12/2014

Technical Manual

MDT Heating actuators

AKH – 0400.01

AKH – 0800.01



1 Content

1 Content.....	2
2 Overview.....	4
2.1 Overview devices.....	4
2.2 Usage & Areas of use.....	4
2.3 Exemplary circuit diagram.....	5
2.4 Structure & Handling.....	6
2.5 Functions.....	7
2.5.1 Overview Functions.....	8
2.6 Channel-LEDs.....	9
2.7. Settings at the ETS-Software.....	9
2.8. Starting up.....	9
3 Communication objects.....	10
3.1 Overview.....	10
3.2 Global Communication objects.....	10
3.3.1 Communication objects – switching (1 Bit).....	11
3.3.2 Communication objects – continuous (1 Byte).....	11
3.3.3 Communication objects – integrated controller.....	12
3.4 Default settings of the communication objects.....	14
4 Reference ETS-Parameter.....	16
4.1 Setup general.....	16
4.1.1 Device configuration.....	16
4.1.2 Summer/Winter mode.....	17
4.1.3 Heating/Cooling requirement & switchover.....	18
4.1.4 Protection of force fit.....	19
4.1.5 Max. Control value.....	20
4.1.6 Behavior after bus power reset.....	21
4.2 Mode selection.....	22
4.3 Channel Configuration – “switching (1 Bit)”.....	23
4.3.1 General setting.....	23
4.3.2 Blocking function.....	25
4.3.3 Emergency mode.....	25
4.3.4 Forced position/Dew point alarm.....	26

4.4 Channel Configuration – “continuous (1 Byte)”	28
4.4.1 PWM cycletime.....	29
4.4.2 Limitation of the control value	32
4.4.3 Flow temperature limit	33
4.5 Channel Configuration – “integrated controller”	34
4.5.1 Operating modes	36
4.5.2 Priority of the operating modes	38
4.5.3 Operating mode switchover	38
4.5.4 Setpoint offset	41
4.5.5 Message function	43
4.5.6 Heating/Cooling system	44
4.5.7 Additional settings at combined heating & cooling mode	46
5 Index	47
5.1 Register of Illustrations	47
5.2 List of tables.....	48
6 Attachment.....	50
6.1 Statutory requirements.....	50
6.2 Routine disposal	50
6.3 Assemblage.....	50
6.4 Controller.....	51
6.4.1 2-Step control.....	51
6.4.2 PI-control continuous	52
6.4.3 PI-control switching (PWM)	53
6.5 Direction of controller	54
6.5 Datasheet	54

2 Overview

2.1 Overview devices

The manual refers to the following devices (Order number respectively written in bold letters):

- **AKH-0400.01** Heating actuator 4-fold, 2TE, 24 or 230V AC, MRDC
 - 4 channels for electrothermic valve drives, for the maximum number of electrothermic valve drives have a look at 6.5 Datasheet, detection of 230V AC failure, 230V AC/24V AC short circuit detection of connected load
- **AKH-0800.01** Heating actuator 8-fold, 2TE, 24 or 230V AC, MRDC
 - 8 channels for electrothermic valve drives, for the maximum number of electrothermic valve drives have a look at 6.5 Datasheet, detection of 230V AC failure, 230V AC/24V AC short circuit detection of connected load



Attention: Every actuator can be connected to 230V AC or 24V AC.
A mixture of both voltages forbidden!

2.2 Usage & Areas of use

The heating actuator can be connected to 24V AC or 230V AC, so it allows controlling electrothermic valve drives with 24V AC or 230V AC. The heating actuator is available at the design of 4-fold or 8-fold.

Integrated 230V AC failure detection as well as short circuit detection, for both voltage types, at the load allows a high fail-safety. Additional an emergency mode can be adjusted, which gets active when the cyclic control value fails.

The actuator can be controlled as well by a 1 Bit object as by a 1 Byte object. As special feature, the controller contains of an integrated controller, which allows controlling the actuator directly by a temperature value. The integrated controller contains of the 4 operating modes, comfort, night, standby, and frost-/heat protection. The setpoints can be adjusted individual for the single operating modes as well as for the heating and cooling mode.

A limitation of the control value, summer /winter mode as well as a protection of the valves completes the range of service of the heating actuator.

2.3 Exemplary circuit diagram

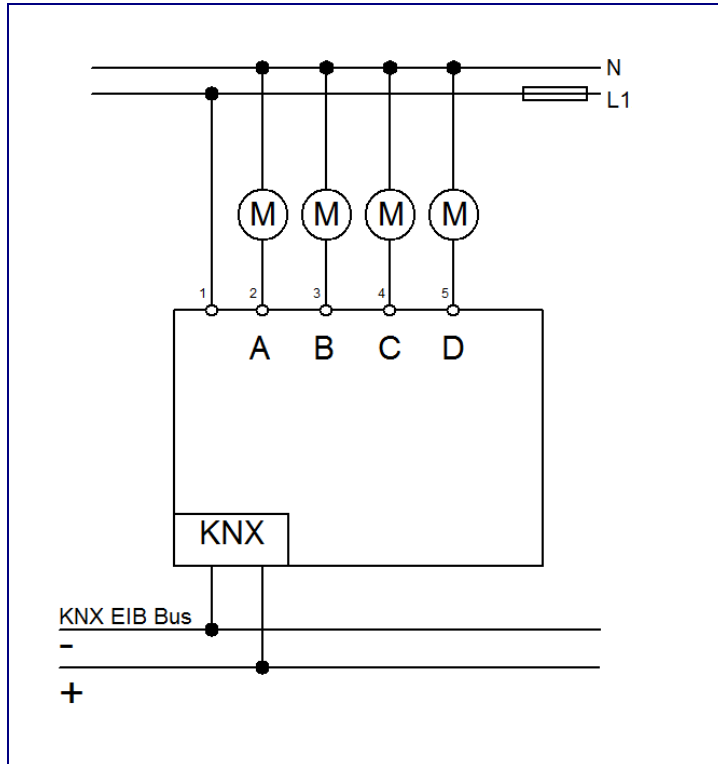

Figure 1: Exemplary circuit diagram heating actuator 4-fold 230V

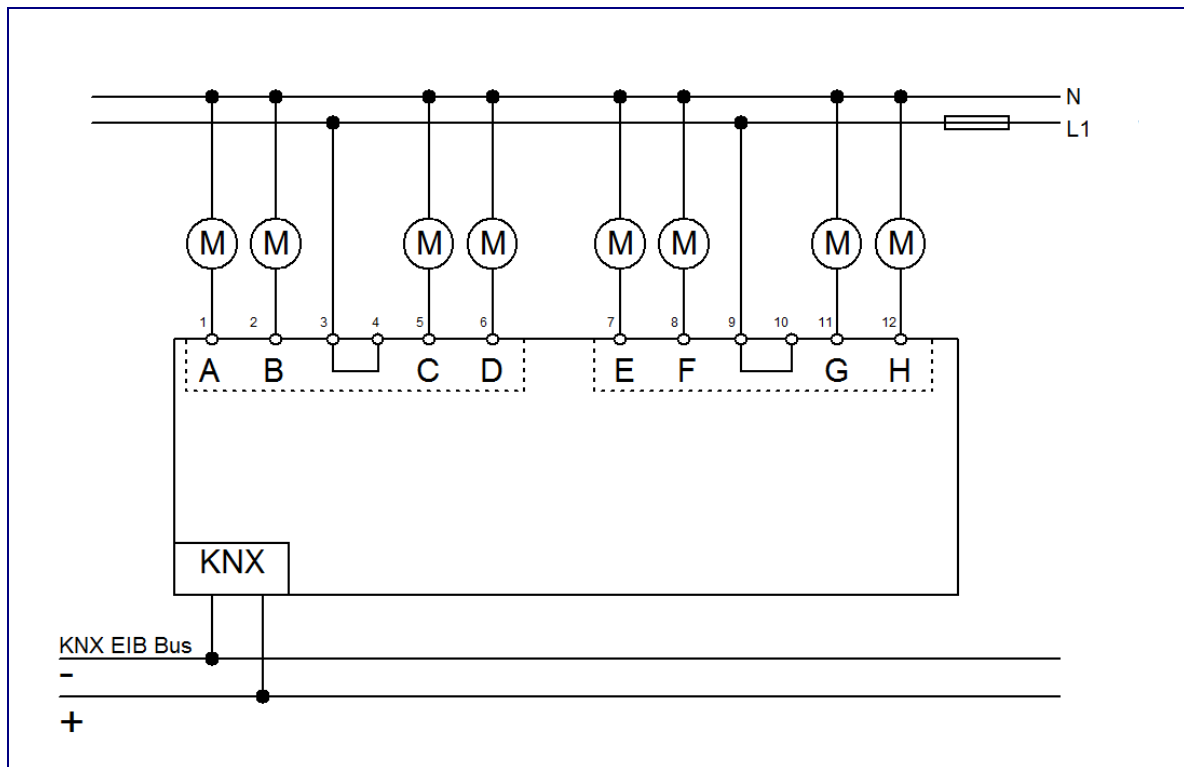

Figure 2: Exemplary circuit diagram heating actuator 4-fold 230V

2.4 Structure & Handling

The heating actuator, here a 4-fold actuator is shown, contains of the standard elements programming-knob, programming-LED, which shows an active programming mode, and a bus-connection.

The electrothermic valve drives can be connected by the terminal strip with respecting the circuit diagrams.

Every single channel contains of a status-LED, which shows an active channel by a slow flashing. The ratio of on to off corresponds the current control value. A significant faster flashing of the LEDs shows an active disturbance of this channel.

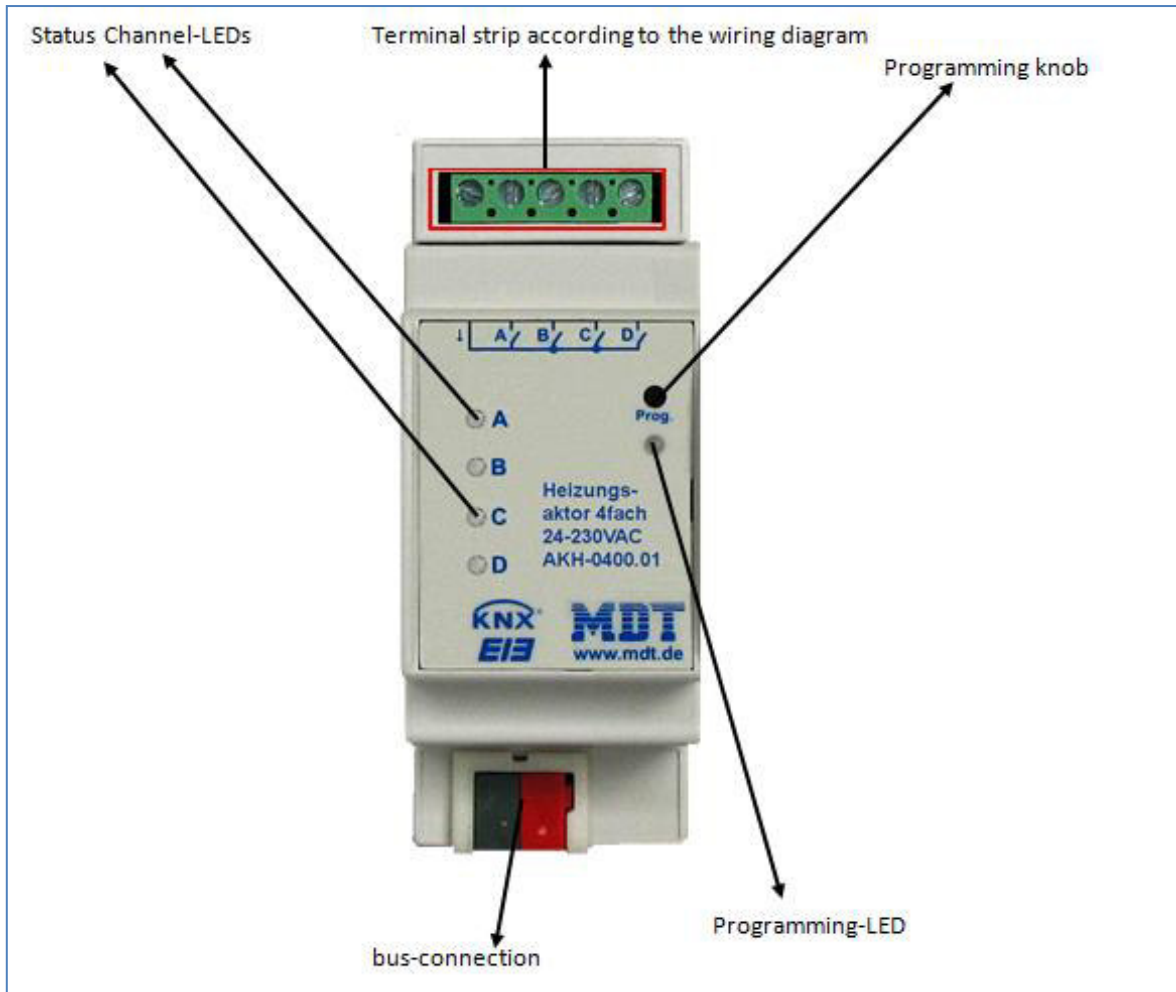

Figure 3: Overview hardware module

2.5 Functions

The functions are identical for all channels. According to the hardware specification, the device contains of up to 8 channels-

The labeling of the channels is in alphabetically consecutive order.

The general settings are the same for all of the channels.

There are 4 possible functions for each channel:

- **Channel**
The channel has no function. So there are not any parameterization options for this channel.
- **switching (1 Bit)**
The channel works with a 1 Bit value for the control value, e.g. from a two-step controller or a PWM-signal. So the output can only be switched on or off at a change of the 1 Bit Input signal.
By further options like valve type, activatable blocking objects, activatable emergency mode and dew point alarm as well as status objects, the channel can be adjusted for the present valve type.
- **continuous (1 Byte)**
The channel works with 1 Byte value for the control value, e.g. from a PI-controller. The Input signal is transmitted to the valve by a PWM-controller with adjustable cycle time.
Next to the same parameterization options like the 1 Bit input value, the actuator contains of limitations for the control value and the flow temperature at the 1 Byte mode.
- **integrated controller**
When a channel is selected as integrated controller, the channel creates an own continuous control value from an existing temperature value. This continuous control transmitted to the switching output by a PWM-signal.
Next to the same parameterization options as by the 1 Byte input value, the actuator contains of a lot additional settings for the controller at the integrated controller mode.

2.5.1 Overview Functions

General settings	Settings	<ul style="list-style-type: none"> • Startup delaytime • Selection of 24V AC or 230V AC mode • Objects for requirement Heating/Cooling activatable • Adjustment of heating/colling switchover • Protection of forse fit activatable • Behavior after bus power reset • Summer/Winter mode adjustable
	Channel selections	<ul style="list-style-type: none"> • switching (1Bit) • continous (1Byte) • integrated controller
switching (1 Bit)	Switching functions	<ul style="list-style-type: none"> • Valve type adjustable • Blocking objects activatable • Adjustable emergency mode • Forced position/dew point alarm adjustable • Status objects for the control value activatbale
continuous (1 Byte)	Switching functions	<ul style="list-style-type: none"> • same as switching-mode (1Bit)
	Control value functions	<ul style="list-style-type: none"> • PWM-cycle time parameterize able • Minimum & Maximum limitation of the control value at heating parameterize able • Minimum & Maximum limitation of the control value at cooling parameterize able • Flow temperature limit (additional temperature sensor at the flow requested)
integrated controller	Switching functions	<ul style="list-style-type: none"> • same as switching-mode (1Bit)
	Control value functions	<ul style="list-style-type: none"> • same as continuous-mode (1Byte)
	Controller functions	<ul style="list-style-type: none"> • System (2 Pipe/4 Pipe) adjustable • 4 modes individual parameterize able • Priority of the modes adjustable • Switchover of the mode by Bit or Byte object available • Setpoint shift parameterize able • Message for exceeded/underflow of adjustable temperature available • Heating-/Cooling system by control parameters adjustable

Table 1: Overview functions

2.6 Channel-LEDs

Every channel contains of a LED, which shows the current state of the channel. Additional to the status, these LEDs show errors of the channels.

The errors are shown as described below:

- **only one of the channel-LEDs flashes (7x fast flashing, short brack, 7x fast flashing, ...)**
The belonging channel is at the overload mode or has a short circuit at the output.
At the 230V mode a mains voltage failure can additional be recognized. Because often 4 channels are supplied in common, all 4 channels are flashing.
- **all channel-LEDs flashing**
At the four fold actuator, the first channel must be always connected to a load. At the 8-fold actuator, additional the fifth channel must be connected to a load. Otherwise the actuator will switch to the error mode and show this by a flashing off all channel-LEDs.

The normal behavior of the actuator is also shown via these LEDs as described below:

- **switching mode (1 Bit)**
The LED shows the switching behavior of the output. If the 2-step controller sends a 1-signal, the LED is switched on.
- **continuous mode (1 Byte)/ integrated controller**
The LED operates at the PWM mode with the fixed period of 4s and flashes with the cadence of the control value. At a control value of 50%, the LED will shine for 2s and will be off for 2s.

2.7. Settings at the ETS-Software

Auswahl in der Produktdatenbank

Manufacturer: MDT Technologies

Product family: Actuator

Product type: Heating Actuators

Medium Type: Twisted Pair (TP)

Product name: addicted to the used type, e.g.: AKH-0800.01 Heating actuator 8-fold, 4TE

Order number: addicted to the used type, e.g.: AKH-0800.01

2.8. Starting up

After wiring, the allocation of the physical address and the parameterization of every channel follow:

- (1) Connect the interface with the bus, e.g. MDT USB interface
- (2) Set bus power up
- (3) Press the programming button at the device(red programming LED lights)
- (4) Loading of the physical address out of the ETS-Software by using the interface(red LED goes out, as well this process was completed successful)
- (5) Loading of the application, with requested parameterization
- (6) Switch the power supply on
- (7) If the device is enabled you can test the requested functions(also possible by using the ETS-Software)

3 Communication objects

3.1 Overview

The communication objects are for programming the actuator. The assignment can be done by these objects.

For every channel, 20 objects are reserved. The communication objects for the single channels have only influence to the belonging channels. The numbering of the communication objects is standardly done this way, also if not all of the 20 objects are used or a channel is completely deactivated. So the channel A has the objects from 0 to 19, the channel B from 20 to 39 and so on.

After the objects for the single channels, the global valid objects are following. These objects can have influence to all channels. At the 4-fold actuator, these objects start with number 80 and at the 8-fold actuator with the number 160.

3.2 Global Communication objects

The global communication objects are following to the objects of the single channels. According to the parameterization maximum 6 global objects can be shown. The first two objects, numbers 80/160 and 81/161, are for the switchover of summer/winter mode and for the switchover of heating/cooling. The two following objects are state objects of the size of 1 Bit. The object 82 sends a 1, if at least one channel is active. The object 83/163 reports an error. The last two objects have the size of 1 Byte and are for the shifting of the maximum control value or the responding of the current value. The maximum control value can be adjusted by object 85/165; the object 84/164 sends the current maximum.

The following illustration shows the global communication objects:

Number	Name	Object Function	Description	Group...	Length	C	R	W	T	U
80/160	Summer / Winter	Switchover			1 bit	C	-	W	T	-
81/161	Heating / Cooling	Switchover			1 bit	C	-	W	T	-
82/162	Heating / Cooling requirement	0 if all valves closed, els...			1 bit	C	R	-	T	-
83/163	Fault	At power failure/short c...			1 bit	C	R	-	T	-
84/164	Max. control value	Output			1 Byte	C	R	-	T	-
85/165	Max. control value	Input			1 Byte	C	-	W	-	-

Figure 4: global Communication objects (AKH-0800.01)

Die nachfolgende Tabelle zeigt die 6 globalen Kommunikationsobjekte:

Nr.	Function	Usage	
80/160	Summer/Winter	Switchover	In, Write
81/161	Heating/Cooling	Switchover	In, Write
82/162	Heating/Cooling requirement	Status Heating/Colling mode	In, Read
83/163	Fault	Display of power failure/short circuit	Out, Read
84/164	Max. control value	Status of the current maximum control value	Out, Read
85/165	Max. control value	Adjustment of the maximum control value	Out, Write

Table 2: global Communication objects

3.3 Communication Objects per Channel

According to the setting, different objects are shown for this channel. The following sections show the communication objects for each state. The numbers of the communication objects are always shown for channel A. At channel B, the numbers would be increased by 20, at channel C by 40 and so on.

3.3.1 Communication objects – switching (1 Bit)

If a channel is selected as „switching (1 Bit)“, the following objects, depending to the parameterization, will be shown:

Number	Name	Object Function	Description	Group...	Length	C	R	W	T	U
0	Channel A	Control value			1 bit	C	-	W	T	-
2	Channel A	Block			1 bit	C	-	W	-	-
3	Channel A	State control value			1 bit	C	R	-	T	-
4	Channel A	Message emergency m...			1 bit	C	R	-	T	-
5	Channel A	Dew point alarm			1 bit	C	-	W	-	-

Figure 5: Communication objects „switching (1Bit)“

The control value is executed as 1 Bit value. Furthermore additional objects, depending to the parameterization, are available.

The chart shows the available objects:

Nr.	Function	Usage	
0	Control Value	Input for external control value	In, Write
2	Block	blocks the channel	In, Write
3	State control value	sends the current value of the control value	Out, Read
4	Message emergency mode	indicates an active emergency mode	Out, Read
5	Forced position	activates the forced position	In, Write
5	Dew point alarm	activates the dew point alarm	In, Write

Table 3: Communication objects „switching(1Bit)“

3.3.2 Communication objects – continuous (1 Byte)

If a channel is selected as „continuous (1Byte)“, the following objects, depending to the parameterization, are shown:

Number	Name	Object Function	Description	Group...	Length	C	R	W	T	U
0	Channel A	Control value			1 Byte	C	-	W	T	-
1	Channel A	Flow temperature			2 Byte	C	-	W	-	-
3	Channel A	State control value			1 Byte	C	R	-	T	-
4	Channel A	Message emergency m...			1 bit	C	R	-	T	-
5	Channel A	Forced position			1 bit	C	-	W	-	-

Figure 6: Communication objects „continuous (1Byte)“

The control value is executed as 1 Byte value. Furthermore additional objects, depending to the parameterization, are available.

The chart shows the available objects:

Nr.	Function	Usage	
0	Control value	Input for external control value	In, Write
1	Flow temperature	Adjustment of the limitation of the flow temperature	In, Write
2	Block	blocks the channel	In, Write
3	State control value	sends the current value of the control value	Out, Read
4	Message emergency mode	indicates an active emergency mode	Out, Read
5	Forced position	activates the forced position	In, Write
5	Dew point alarm	activates the dew point alarm	In, Write

Table 4: Communication objects „continuous(1Byte)“

3.3.3 Communication objects – integrated controller

If a channel is selected as integrated controller, the following objects, depending to the parameterization, will be shown:

Number	Name	Object Function	Description	Group...	Length	C	R	W	T	U
0	Channel A	Temperature value			2 Byte	C	-	W	T	-
1	Channel A	Flow temperature			2 Byte	C	-	W	-	-
3	Channel A	State control value			1 Byte	C	R	-	T	-
4	Channel A	Message emergency m...			1 bit	C	R	-	T	-
5	Channel A	Forced position			1 bit	C	-	W	-	-
7	Channel A	Setpoint comfort			2 Byte	C	-	W	-	-
8	Channel A	Setpoint value offset			2 Byte	C	-	W	-	-
10	Channel A	Mode selection			1 Byte	C	-	W	T	-
11	Channel A	DPT_HVAC Status			1 Byte	C	R	-	T	-
12	Channel A	DPT_RHCC Status			2 Byte	C	R	-	T	-
13	Channel A	Mode comfort			1 bit	C	R	W	-	-
14	Channel A	Mode night			1 bit	C	R	W	-	-
15	Channel A	Mode frost/heat protect...			1 bit	C	R	W	-	-
16	Channel A	Frost alarm			1 bit	C	R	-	T	-
17	Channel A	Heat alarm			1 bit	C	R	-	T	-

Figure 7: Communication objects „integrated controller“

Because of the control value is created by the integrated controller itself, no object for the control value is shown. Instead of this, an object for the temperature measurement (Input) is shown.

The chart shows the available objects:

Nr.	Function	Usage	
0	Temperature Value	Input for external temperature value	In, Write
1	Flow temperature	Input for external temperature signal of the flow temperature	In, Write
2	Block	blocks the channel	In, Write
3	State control value	sends the actual control value	Out, Read
4	Message emergency mode	indicates active emergency mode	Out, Read
5	Forced position	activates the forced position	In, Write
5	Dew point alarm	activates the dew point alarm	In, Write
6	PWM-Cooling for 4 Pipe system	Output for Cooling at a divided heating/cooling system	Out, Read
7	Setpoint comfort	adjustment of a new absolute setpoint	In, Write
8	Setpoint value offset	Shifting of the actual setpoint	In, Write
9	Actual setpoint	Sending of the actual control value	Out, Read
10	Mode selection	Adjustment of the operating mode	In, Write
11	DPT_HVAC Status	sends feedback of the current operating mode	Out, Read
12	DPT_RHCC Status	sends feedback of the current operating mode	Out, Read
13	Mode comfort	switches mode comfort	In, Write
14	Mode night	switches mode night	In, Write
15	Mode frost/heat protection	switches mode frost/heat protection	In, Write
16	Frost alarm	reports an active frost alarm	Out, Read
17	Heat alarm	reports an active heat alarm	Out, Read

Table 5: Communication objects integrated controller

3.4 Default settings of the communication objects

The following chart shows the default settings of the communication objects:

Default settings									
Nr.	Name	Object Function	Length	Priority	C	R	W	T	U
0	Channel A	Control value	1 Bit	Low	X		X	X	
0	Channel A	Control value	1 Byte	Low	X		X	X	
0	Channel A	Temperature value	2 Byte	Low	X		X	X	
1	Channel A	Flow temperature	2 Byte	Low	X		X		
2	Channel A	Block	1 Bit	Low	X		X		
3	Channel A	State control value	1 Bit	Low	X	X		X	
3	Channel A	State control value	1 Byte	Low	X	X		X	
4	Channel A	Message emergency mode	1 Bit	Low	X	X		X	
5	Channel A	Forced position	1 Bit	Low	X		X		
5	Channel A	Dew point alarm	1 Bit	Low	X		X		
6	Channel A	PWM-Cooling for 4 Pipe system	1 Byte	Low	X	X		X	
7	Channel A	Setpoint comfort	2 Byte	Low	X		X		
8	Channel A	Setpoint value offset	2 Byte	Low	X		X		
9	Channel A	Actual setpoint	2 Byte	Low	X	X		X	
10	Channel A	Mode selection	1 Byte	Low	X		X	X	
11	Channel A	DPT_HVAC Status	1 Byte	Low	X	X		X	
12	Channel A	DPT_RHCC Status	2 Byte	Low	X	X		X	
13	Channel A	Mode comfort	1 Bit	Low	X	X	X		
14	Channel A	Mode night	1 Bit	Low	X	X	X		
15	Channel A	Mode frost/heat protection	1 Bit	Low	X	X	X		
16	Channel A	Frost alarm	1 Bit	Low	X	X		X	
17	Channel A	Heat alarm	1 Bit	Low	X	X		X	
+20	next Channel								
80/160	Summer/Winter	Switchover	1 Bit	Low	X		X	X	
81/161	Heating/Cooling	Switchover	1 Bit	High	X		X	X	
82/162	Heating/Cooling requirement	0 if all valves closed, else 1	1 Bit	High	X	X		X	
83/163	Fault	At power failure/short circuit	1 Bit	High	X	X		X	
84/164	Max. control value	Output	1 Byte	High	X	X		X	
85/165	Max. control value	Input	1 Byte	High	X		X		

Table 6: Default-settings of the communication objects

You can see the default values for the communication objects from the upper chart. According to requirements the priority of the particular communication objects as well as the flags can be adjusted by the user. The flags allocate the function of the objects in the programming thereby stands C for communication, R for Read, W for write, T for transmit and U for update.

4 Reference ETS-Parameter

4.1 Setup general

The general settings are shown at the illustration below. These settings are valid for all channels:

Setup general	
Startup delaytime	0 s
Thermal driving	230V
Object for requirement Heating/Cooling	send 1 if required
Switching for cooling	via object Cooling
Polarity for object "Summer/Winter"	Summer = 1 / Winter = 0
Protection of force fit (all 6 days for 5 min valve open/close)	active
Object max. control value	send at changes and at cycle 30min
Behavior after bus power reset	Request object Summer/Winter and control val.

Figure 8: Setup general

4.1.1 Device configuration

The following both parameters are for the configuration of the actuator:

Startup delaytime	0 s
Thermal driving	<ul style="list-style-type: none"> 230V 24V 230V

Figure 9: Device configuration

The following chart shows the dynamic range of this parameter:

Sub function	Dynamic range [default value]	comment
Startup delaytime	0-60s [0s]	Time, which elapses between bus power reset and the restart of the device
Thermal driving	<ul style="list-style-type: none"> ▪ 24V ▪ 230V 	Adjustment of the voltage level at the thermal drivings

Table 7: Device configuration

The startup delay time defines the time, which elapses between a bus power return or an ETS-Download and the functional restart of the device.

The setting of the voltage level defines the voltage for the connected thermal drives. This setting changes only the fault detection, other functions are identical. At the 230V mode, the fault detection recognizes power failure as well as short circuits. At the 24V mode only short circuits are recognized. If a fault is detected, a 1-signal is sent by the belonging communication object. Additional, the channel, which is in the fault mode, reacts with a fast flashing of the belonging channel LED. If the 230V main voltage failures, all 4 channels flash, which are connected to this L-connection.

Number	Name	Length	Usage
83/163	Fault	1 Bit	reports an active fault

Table 8: Communication object fault



Attention: The first channel of the 4-fold actuator as well as the first and fifth channel of the 8-fold actuator has to be connected first. Otherwise a fault will be detected!

Attention: Every actuator can operate only one voltage, either 230V or 24V. A combination of both voltages is forbidden because of the conductor track distances!

4.1.2 Summer/Winter mode

At the following settings, the summer/winter mode can be adjusted:

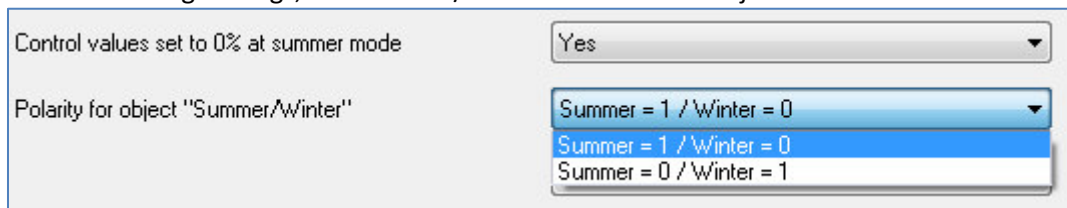

Figure 10: Summer/Winter mode

The following chart shows the dynamic range for this parameter:

Sub function	Dynamic range [default value]	comment
Control values set to 0% at summer mode	<ul style="list-style-type: none"> ▪ Yes ▪ No 	If this setting is active, the control value will set to 0% at summer mode
Polarity for object "Summer/Winter"	<ul style="list-style-type: none"> ▪ Summer=1/Winter=0 ▪ Summer=0/Winter=1 	Adjustment of the polarity for switchover

Table 9: Summer/Winter mode

The heating actuator can be set in a summer or winter mode. The polarity of the switchover object can be adjusted.

Additional a setting can be made which sets the control value continuous to 0% at the summer mode. Of course, this setting can only be done if a switchover between heating and cooling is disabled (have a look at 4.1.3). So the actuator works only at the heating mode.

Number	Name	Length	Usage
80/160	Summer/Winter	1 Bit	Switchover between summer and winter mode

Table 10: Communication object Summer/Winter mode

4.1.3 Heating/Cooling requirement & switchover

The switchover for heating and cooling defines whether the heating actuator shall switch a cooling or not:

Object for requirement Heating/Cooling	send 1 if required
Switching for cooling	inactive
Control values set to 0% at summer mode	Yes

Figure 11: Heating/Cooling switchover

The following chart shows the dynamic range for this parameter:

Sub function	Dynamic range [default value]	comment
Object for requirement Heating/Cooling	<ul style="list-style-type: none"> ▪ not active ▪ send 1 if required ▪ send 0 if required ▪ send 1 if required, 20 min power off delay ▪ send 0 if required, 20 min power off delay 	Activation of the object heating/cooling requirement and adjustment of the signal for requirement
Switching for cooling	<ul style="list-style-type: none"> ▪ not active ▪ via object summer/winter ▪ via object cooling 	Adjustment whether the actuator shall switch a cooling or not; defines the switchover between heating and cooling.
Control values set to 0% at summer mode	<ul style="list-style-type: none"> ▪ No ▪ Yes 	This setting can only be done if the cooling is chosen as “not active”.

Table 11: Heating/Cooling switchover

The heating actuator can control as well heating-systems as cooling-systems and combined systems. Adjusting the switchover between heating and cooling can be done by the parameter “Switching for cooling”. This parameter defines whether the switchover shall be done via an own object or via the object “summer/winter”. For each channel can be adjusted individually whether it shall react to the switchover or not.

If the switchover is done by the object summer/winter, the actuator will switch automatically to heating at the winter mode and to cooling at the summer mode. At the switchover via an own object, the switchover will be done via the object “heating/cooling”. A logical “0” switches the cooling on and a logical “1” the heating on.

The setting “Control values set to 0% at summer mode” can only be activated if the heating/cooling switchover is disabled.

Via the parameter “Object for requirement Heating/Cooling” can be adjusted, whether an additional object for the requirement of a heating or cooling process shall be shown. This object has its usage e.g. at a pump control. If all valves are closed, for example the pump can be switched off to save energy. Via the setting “send 0 if required” / “send 1 if required”, the polarity of this object can be defined. The setting “send 1 if required” effects, that the object sends a “1” at a requirement and a “0” when it is not used. The additional power off delay prevents the actuator off a to frequent switching, e.g. at the PWM mode.

The following chart shows the belonging communication objects:

Number	Name	Length	Usage
81/161	Heating/Cooling	1 Bit	Switchover between heating(=1) and cooling(=0)
82/162	Heating/Cooling requirement	1 Bit	sends a “0” if all valves are closed and “1” if one or more are open

Table 12: Communication object Summer/Winter mode

4.1.4 Protection of forse fit

The following illustration shows the settings for this parameter:

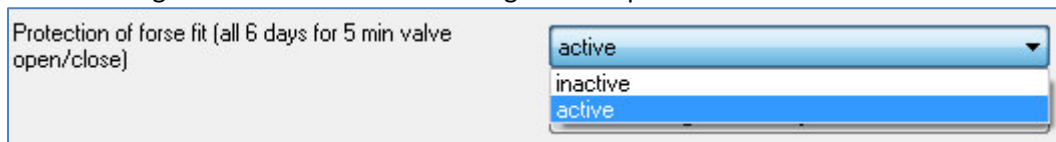

Figure 12: Protection of forse fit

The following chart shows the dynamic range for this parameter:

Sub function	Dynamic range [default value]	comment
Protection of forse fit (all 6 days for 5min valve open/close)	<ul style="list-style-type: none"> ▪ inactive ▪ active 	activates the protection of forse fit

Table 13: Protection of forse fit

To be sure, that a valves, which was not opened for a long period of time, does not block, the heating actuator has a protection of forse fit. This protection controls all channels at a fixed period of 6 days for 5 min and drives the valves once completely open.

So, a smooth operation of the valves can be secured.

4.1.5 Max. Control value

The following illustration shows the settings for this parameter:

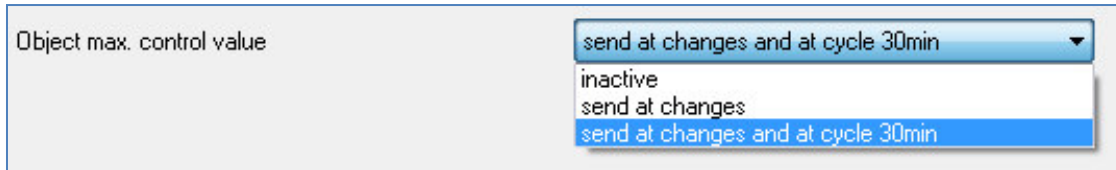

Figure 13: max. Control value

The following chart shows the dynamic range for this parameter:

Sub function	Dynamic range [default value]	comment
Object max. control value	<ul style="list-style-type: none"> ▪ inactive ▪ send at changes ▪ send at changes and at cycle 30min 	Activates the objects for the max. control value and defines the sending behavior of them

Table 14: max. Control value

The parameter “Object max. control value” defines whether an object for the maximum control value shall be shown. If this parameter is activated with one of the two settings, two objects will be shown which you can see at the chart below. The maximum control value is only sent at a change or at a change and additional cyclically every 30min.

This function allows heating’s, which can modulate their power, if only less power is required. The object for the output (Number 84/164) sends the maximum used value at the heating actuator of the enabled channels. Afterwards this output signal can be analyzed and send the used power to the heating.

If more than one heating actuator is used, which get all their heating power from one heating, the objects can be connected by the additional object of the input (Number 85/165). Therefore, the output of the first actuator has to be connected to the input of the second actuator and so on. Now the output object of the last actuator sends the maximum used power from all enabled channels of the connected actuators.

Number	Name	Length	Usage
84/164	Max. control value(Output)	1 Byte	sends the current maximum control value
85/165	Max. control value(Input)	1 Byte	receives the current maximum control value from another actuator

Table 15: Communication objects max. Control value

4.1.6 Behavior after bus power reset

The following illustration shows the settings for this parameter:

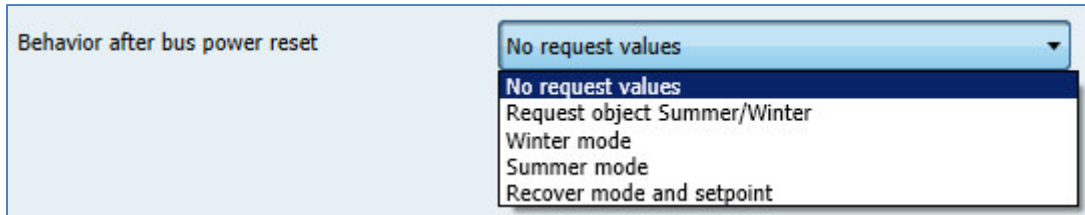

Figure 14: Behavior after bus power reset

The following chart shows the dynamic range for this parameter:

Sub function	Dynamic range [default value]	comment
Behavior after bus power reset	<ul style="list-style-type: none"> ▪ No request values ▪ Request object Summer/Winter ▪ Winter mode ▪ Summer mode ▪ Recover mode and setpoint 	Adjustment, which values shall be requested or which mode shall be activated in case of bus power return.

Table 16: Behavior after bus power reset

The behavior after bus power return defines which values shall be read in case of a bus power return. If no values are read, the actuator will work on as all valves are closed. The setting “Request object summer/winter and control value” achieves that the actuator works on with the values, which he had before a bus power failure.

Additional there are the settings “winter mode” and “summer mode”. These settings cause that the actuator switches at a bus power reset to the winter or summer mode and request the current control values. The setting “Recover mode and setpoint” loads the mode and setpoint, which were active before bus power down.

4.2 Mode selection

Before you can start with the configuration of the channel, you have to select the mode of the channel. The operating mode of a channel is pointed by the given input signal for the control value. The operating mode “switching (1Bit)” processes 1 Bit values, which send only the both states “0” and “1”. These control values are most sent from 2-step-controllers or a PWM converted control value. If a continuous signal, e.g. of a PI-control, is given, you have to select the operating mode “continuous (1 Byte)”. By the mode “integrated controller”, the heating actuator allows you to process these values with a lot of controller functions.

The following illustration shows the selection window for the operation mode of the channels:

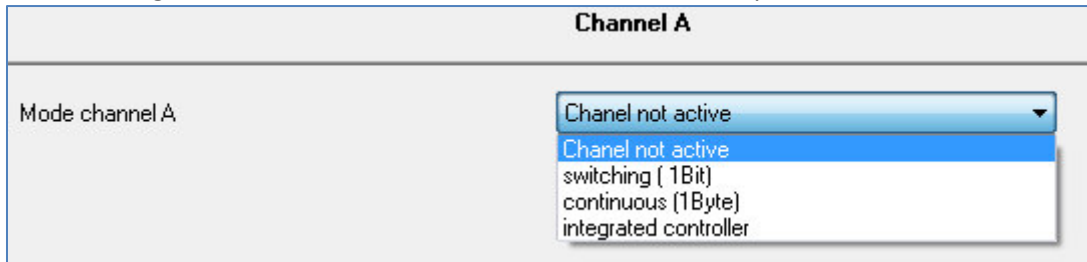

Figure 15: Mode selection

The following chart shows the available operating modes for each channel:

ETS-Text	Dynamic range [default value]	comment
Mode channel A- D/H	<ul style="list-style-type: none"> ▪ Channel not active ▪ switching (1Bit) ▪ continuous (1Byte) ▪ integrated controller 	Adjustment of the operating mode for the channel.

Table 17: Mode selection

4.3 Channel Configuration – “switching (1 Bit)”

If the channel is selected as “switching (1 Bit)”, the following parameterization options are shown at the submenu for the channel:

Channel A	
Mode channel A	switching (1Bit) ▼
Valve type	not energized closed ▼
Block object	active ▼
Regard channel in Heating / Cooling requirement and max. control value	Yes ▼
Emergency mode	inactive ▼
Forced position / dew point alarm	inactive ▼
Send state control value	at changes ▼

Figure 16: Channel configuration – “switching”

As soon as the channel is selected as “switching (1 Bit)”, a communication object of the size 1 Bit is shown for the control value. This object must be connected to the object, which shall be used to control the valve, via a group address. The incoming signal for the control value can e.g. be sent from Room temperature controller like the SCN-RT, which is adjusted as 2 step controller or as PWM-controller.

Number	Name	Length	Usage
0	Control value	1 Bit	Processes the incoming control value

Table 18: Communication object Control value 1Bit

4.3.1 General setting

The first basic setting is to choose which type of valves, normally closed or normally opened, is given. So the actuator can transmit the right values to the valves:

Sub function	Dynamic range [default value]	comment
Valve type	<ul style="list-style-type: none"> ▪ not energized closed ▪ not energized opened 	Adjustment of the valve type

Table 19: Valve type

This setting is to configure the output, that it can transmit the right switching state to the output according to the given signal. This is only an adaption to normally closed or normally opened contacts of the valves. At the setting “not energized closed”, the output signal is inverted.

Furthermore it can be adjusted, whether a channel shall be integrated in the Heating/cooling requirement and the maximum control value of the general settings:

Sub function	Dynamic range [default value]	comment
Regard channel in heating/cooling requirement and max. control value	<ul style="list-style-type: none"> ▪ Yes ▪ No 	Adjustment whether the channel shall be integrated in the calculation of the max. control value and the heating/cooling requirement.

Table 20: Heating/cooling requirement

If this setting is activated, the actuator will integrate this channel in the calculation of the max. control value and the heating/cooling requirement.

You can adjust for every channel, whether a state object for the control value shall be shown or not. Furthermore the sending conditions are selectable:

Sub function	Dynamic range [default value]	comment
Send state control value	<ul style="list-style-type: none"> ▪ inactive ▪ at changes ▪ at enquiry 	Adjustment, whether a state object of the control value shall be shown and when it shall send its actual value

Table 21: Send state control value

If this parameter is chosen as “inactive”, no additional object for the state of the control value is shown. At the setting sending at changes, the communication object sends the state of the control value at every change. The setting sending at enquiry activates a passive state object. This object sends its actual value only at a request.

The communication for the state of the control value has always the same size as the control value itself:

Number	Name	Length	Usage
3	State control value	1 Bit	sends/responds the actual value of the control value

Table 22: Communication object state control value

4.3.2 Blocking function

You can activate or deactivate a block object for every channel:

Sub function	Dynamic range [default value]	comment
Block object	<ul style="list-style-type: none"> ▪ inactive ▪ active 	Activation/deactivation of the blocking function

Table 23: Blocking function

A channel can be blocked for further operations by its blocking object. The blocking is triggered by sending a logical "1" at the belonging block object. Only through sending a logical "0", the channel is unblocked again. A blocked channel is switched off (control value = 0%). After deactivation of the blocking process, the channel assumes the values, which he had before the blocking process. If telegrams are sent to the channel during the block process, no changes will be happen. But the channel takes the value of the last telegram after unblocking.

Number	Name	Length	Usage
2	Block	1 Bit	blocks the belonging channel

Table 24: Communication object blocking function

4.3.3 Emergency mode

An emergency mode can be activated and adjusted for every channel. An activated emergency mode is shown at the following illustration:

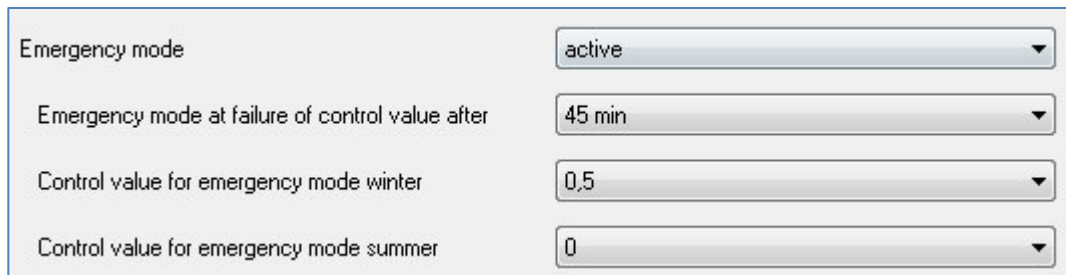

Figure 17: Emergency mode

The dynamic range for the emergency mode is shown at the chart below:

Sub function	Dynamic range [default value]	comment
Emergency mode	<ul style="list-style-type: none"> ▪ inactive ▪ active 	Activation/deactivation of the emergency mode
Emergency mode at failure of control value after	inactive, 30min, 35min, 40 min,...,90min [45min]	Adjustment, when an emergency shall be activated
Control value for emergency mode winter	100%, 90%, 80%, ..., 0% [50%]	Adjustments for control value of the emergency mode at winter
Control value for emergency mode summer	100%, 90%, 80%, ..., 0% [0%]	Adjustments for control value of the emergency mode at summer

Table 25: Emergency mode

As soon as the emergency mode is activated, further settings are for the emergency mode available. The setting “Emergency mode at failure after change of” adjusts the time when the channel shall be activating the emergency mode. Every communication object of the control value needs a cyclic incoming value. When the adjusted time runs out, the channel switches to the emergency mode. At the operating mode “integrated controller”, the emergency mode is triggered when the heating actuator does not receive a temperature value for the adjusted time. For both operating modes, summer and winter, a fixed value can be adjusted for an emergency mode. The fixed value can be adjusted in a percental value from 0-100%. The fixed value is converted into a PWM-signal with a fixed PWM-cycle of 10min. This setting prevents the heating of an unchecked use in case of a failure of the temperature controller.

4.3.4 Forced position/Dew point alarm

Additional for every channel a forced position or a dew point alarm can be activated:

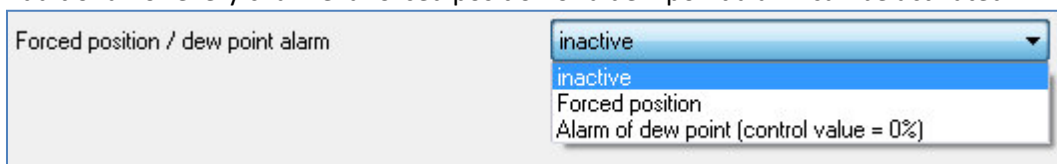

Figure 18: Forced position/Dew point alarm

The dynamic range of this parameter is shown at the chart:

Sub function	Dynamic range [default value]	comment
Forced position/ dew point alarm	<ul style="list-style-type: none"> ▪ inactive ▪ active 	Activation of a forced position or a dew point alarm

Table 26: Forced position/Dew point alarm

If a dew point alarm is selected a further communication is shown. By sending a logical “1”, the dew point alarm is activated. A logical “0” deactivates the dew point alarm again. The dew point alarm sets the control value at the cooling mode to 0%:

Number	Name	Length	Usage
5	Dew point alarm	1 Bit	activates the dew point alarm

Table 27: Communication object dew point alarm

If a forced position is activated, new setting options will be available, which are shown at the chart below:

Sub function	Dynamic range [default value]	comment
Forced position/ dew point alarm	Forced position	Forced position is activated
Control value for forced position winter	100%, 90%, 80%, ..., 0% [50%]	Adjustment of the control value at the winter mode by an activated forced position
Control value for forced position summer	100%, 90%, 80%, ..., 0% [0%]	Adjustment of the control value at the summer mode by an activated forced position

Table 28: Forced position

The forced position drives the control value to a fixed position. Thereby, the forced position differences between the summer and the winter mode. For both modes are fixed values of 0% to 100% parameterizing able. The heating actuator works at the forced value as PWM controller with a fixed PWM-cycle of 10min.

A logical "1" activates the forced position. By sending a logical "0", the forced position is deactivated and the channel goes back to its last value or the last received telegram for the control value.

Number	Name	Length	Usage
5	Forced position	1 Bit	activates the forced position

Table 29: Communication object forced position

4.4 Channel Configuration – “continuous (1 Byte)”

If the channel is selected as “continuous (1 Byte)”, the following parameterization options are shown:

Channel A

Mode channel A	continuous (1Byte) ▼
Valve type	not energized closed ▼
PWM cycletime (min)	10 min ▼
Minimum limit of control value at heating	0 ▼
Maximum limit of control value at heating	1 ▼
Minimum limit of control value at cooling	0 ▼
Maximum limit of control value at cooling	1 ▼
Flow temperature limit	inactive ▼
Block object	inactive ▼
Regard channel in Heating / Cooling requirement and max. control value	Yes ▼
Emergency mode	inactive ▼
Forced position / dew point alarm	inactive ▼
Send state control value	at changes ▼

Figure 19: Channel configuration – “continuous”

The operating mode “continuous (1 Byte)” has the same settings like the operating mode “switching (1 Bit)”. These settings are not described again at this section.

There are additional settings available at the operating mode “continuous”, which are described at the following sections.

The control value and the state object for the control value have the size of 1 Byte at this operating mode. So the control value needs continuous values, e.g. from a PI-controller:

Number	Name	Length	Usage
0	Control value	1 Byte	Processes the incoming control value
3	State control value	1 Byte	State object of the actual control value

Table 30: Communication objects control value – 1 Byte

4.4.1 PWM cycletime

The PWM cycletime is used for calculating the on and off pulses of the control value. This calculation is based on the incoming control value. A PWM cycle includes the whole time which elapses from one switch-on pulse to the next.

Example: If a control value of 75% is calculated and PWM cycletime of 10min is adjusted, the control value will be switched on for 7.5min and switched off for 2.5min.

The dynamic range of the PWM cycletime is shown at the following chart:

Sub function	Dynamic range [default value]	comment
PWM cycletime	1min, 2min, ..., 10min, 15min, 20min, 25min, 30min [10min]	Adjustment of the PWM cycletime

Table 31: PWM cycletime

In principle, two different options of adjusting the PWM cycletime enforced. On the one hand the setting in which the valves open completely and close completely during one cycle. And on the other hand the setting in which the cycletime is much less than the adjustment time of the valves and so a average position of the valves is adjusted.

Both adjustment options and the usage of them are shown at the following section. If more than one valve is adjusted, it is recommended to adjust to the slowest one.

Option 1: Cycletime is larger than the adjustment time of the valves

These setting effects, that the valves are driven once completely open and once completely close during one cycletime. So the valve go trough all possible steps during one cycletime.

The adjustment time of the valve is composed by the dead time (time which elapses between controlling the valve and opening the valve) and the real adjustment time of the valve. So the time at wich the valve is really opened is much smaller than the controlling during one PWM cycle.

The principle of this option is shown at the diagram below:

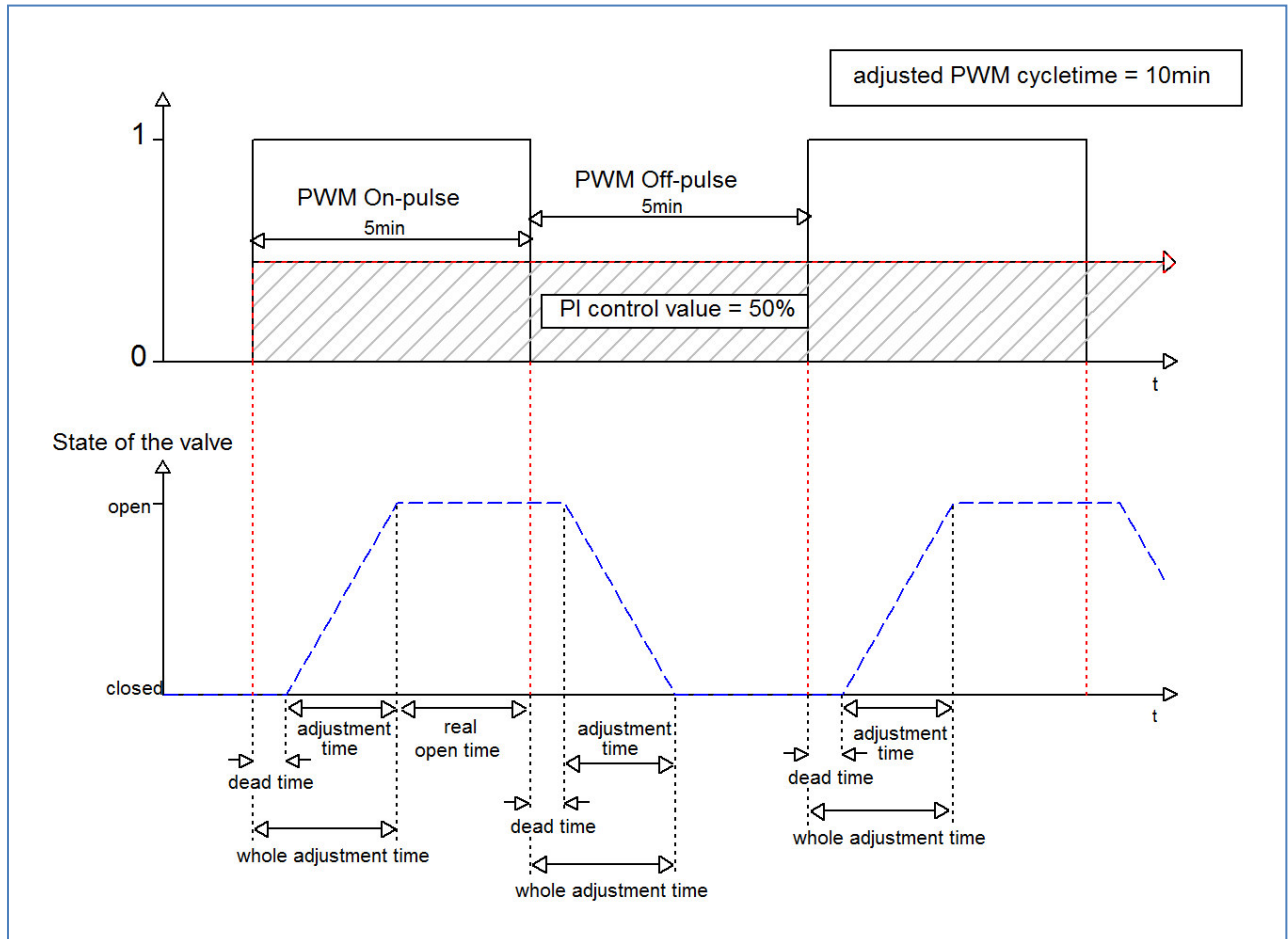

The whole adjustment time is here about 2.5 – 3min. This is a typical adjustment time for underfloor heatings. So the real open or real close time time is around this time smaller than the whole controlling time. Because the adjustment time is needed for a closing and a opening process, the room temperature is controlled precisely.

But this method can also cause larger fluctuation close to the heat source. Furthermore the valves are more heavily loaded by the relatively often driving process.

This setting is proven at slow systems, e.g. underfloor heatings.

Option 2: Cycletime is much smaller than the adjustment time of the valves

These setting effects, that the valves can not be completely opened or closed between one PWM On pulse or a Off pulse. So the valve makes only small moves.

Long-term, this setting effects an average of the vavve-state.

The principle of this option is shown at the diagram below:

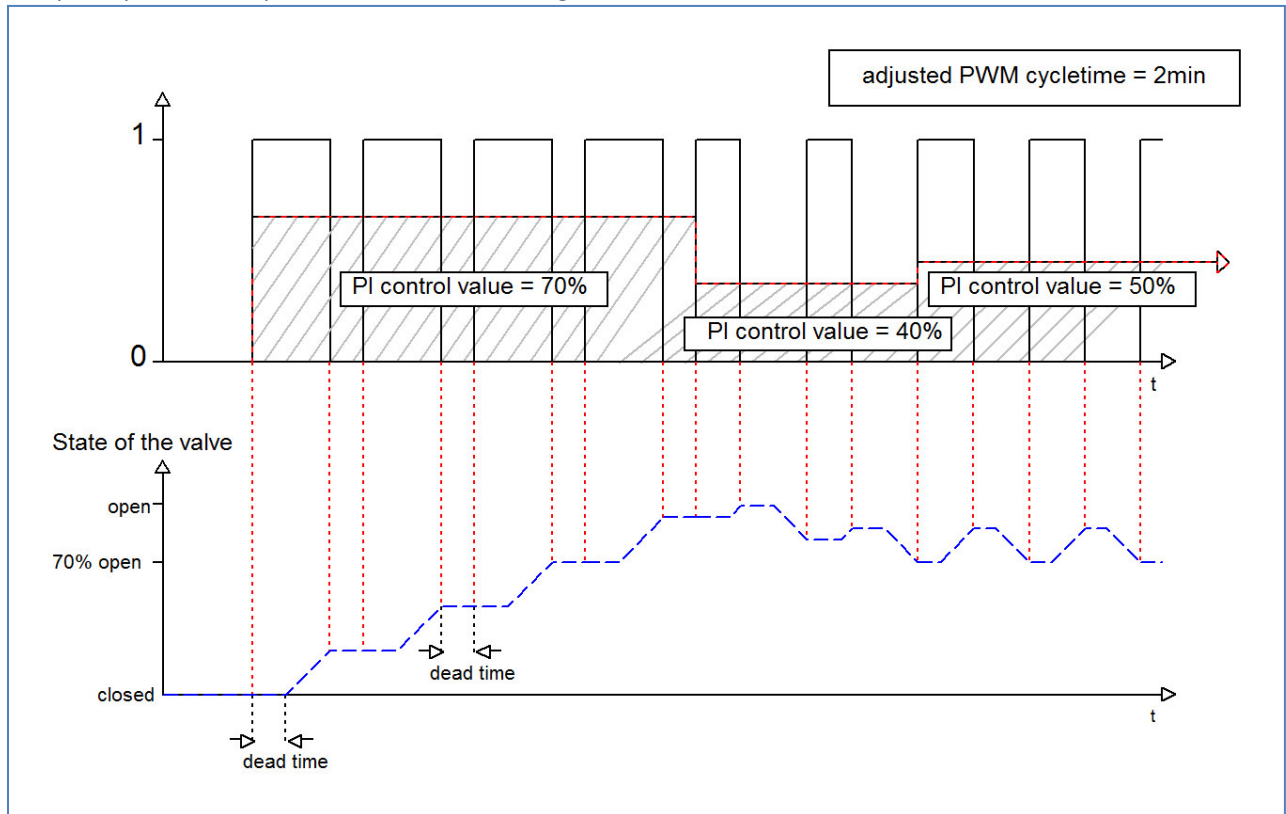

Also here, the whole adjustment time is about 3min. But now the valve can only make small steps during the controlling time. At the beginning, the off-pulse is only as long as dead time and so no adjustment takes place. So the valve drives continuous open. If the temperature increases the adjusted value, the temperature controller readjusts the control value and so the PWM pulse is calculated again. Long-term, an almost continuous value is reached.

To note at this setting is, that the dead times are reduced because of the continuous lowering warm water at the valves. So the real driving times become larger during one controlling process. But because the temperature controller reacts dynamic, it will adapt the control value and so the nearly constant position of the valves is reached.

Advantageous of this method is that the valves are not loaded so much. Furthermore the room temperature is controlled nearly constant by the continuous adaption of the valves.

But if more than one valve is controlled, the average state of the valves is nearly unreachable. So fluctuations of the room temperature can occur.

This setting is proven at fast systems, e.g. radiators.

4.4.2 Limitation of the control value

The control value can be limited as well as at the heating as at the cooling in both directions (minimum and maximum):

Minimale Begrenzung des Stellwertes bei Heizen	0%
Maximale Begrenzung des Stellwertes bei Heizen	100%
Minimale Begrenzung des Stellwertes bei Kühlen	0%
Maximale Begrenzung des Stellwertes bei Kühlen	100%

Figure 20: Limitation of the control value

Die Einstellmöglichkeiten für diesen Parameter sind in der nachfolgenden Tabelle dargestellt:

Sub function	Dynamic range [default value]	comment
Minimum limit of control value at heating	0%, 5%, 10%,...,50% [0%]	Adjustment of the minimum limit of the control value at heating
Maximum limit of control value at heating	100%, 95%, 90%,...,50% [100%]	Adjustment of the maximum limit of the control value at heating
Minimum limit of control value at cooling	0%, 5%, 10%,...,50% [0%]	Adjustment of the minimum limit of the control value at cooling
Maximum limit of control value at cooling	100%, 95%, 90%,...,50% [100%]	Adjustment of the maximum limit of the control value at cooling

Table 32: Limitation of the control value

The limitation of the control value limits the height of the control value, which is transmitted to create a PWM-signal. The limitation is activated, when a value is chosen which is smaller/higher than the possible value for the control value, so minimum larger than 0 or maximum smaller than 1. If an input signal is out of the adjusted limitation, it will be decreased or increased. The PWM signal is calculated from the new input signal.

Example: At the heating mode, the maximum limit is chosen as 70% and the minimum limit is chosen as 10%. The PWM cycletime is adjusted as 10min. If a control value is sent as 100% for the input, the channel takes the maximum limit of 70% and calculates from this value the on-pulse as 7min. A control value in the limitations works normal, so a control value of 50% creates an on-pulse of 5min

The limitation can be parameterized individually as well for the heating as for the cooling. Here the minimum limit is done in the way, so that a control value of 0% also causes a control value of 0%. Every control value above 0% but below the minimum limit is set to the adjusted minimum limit. This behavior is reasonable because of energy saving issues, because otherwise the electrothermic valve drives would consume, even if they are not used, the minimum limit of the nominal power consumption.

4.4.3 Flow temperature limit

For avoiding fluctuations at the control circuit, an additional flow temperature limit can be activated:

Flow temperature limit	active
Flow temperature limit at heating	38 °C
Flow temperature limit at cooling	18 °C

Figure 21: Flow temperature limit

The dynamic range of the flow temperature limit is shown at the following chart:

Sub function	Dynamic range [default value]	comment
Flow temperature limit	<ul style="list-style-type: none"> ▪ inactive ▪ active 	Activation/deactivation of a flow temperature limit
Flow temperature limit at heating	inactive, 25°C, 26°C, 27°C, ...,60°C [38°C]	Adjustment of the maximum flow temperature at heating
Flow temperature limit at cooling	inactive, 15°C, 16°C, 17°C, ...,25°C [18°C]	Adjustment of the minimum flow temperature at cooling

Table 33: Flow temperature limit

The flow temperature limit restricts the actual flow temperature. This allows you, to limit the heating temperature, which is needed in some situations. If for example an underfloor heating must not heat above a certain value to protect the flooring, the heating temperature can be limited by the flow temperature limit. The flow temperature limit needs a second sensor at the flow. This sensor measures the actual flow temperature. The object, which contains the temperature value, must be connected to the object for the flow temperature of the heating actuator. This one limits the flow temperature now, according to the adjusted parameters.

Number	Name	Length	Usage
1	Flow temperature	2 Byte	Processing of the measured flow temperature

Table 34: Communication object flow temperature

4.5 Channel Configuration – “integrated controller”

At the operating mode “integrated controller”, the channel contains of the same parameterization options like at “continuous (1 Byte)” and “switching (1 Bit)”. These functions are not described again in this section. Have a look at the sections 4.3 and 4.4 for these functions. There are a lot of additional functions available, which are described at the following sections.

At the normal menu, the only difference between the operating mode “integrated controller” and the operating mode “continuous” is the selection between heating and cooling.

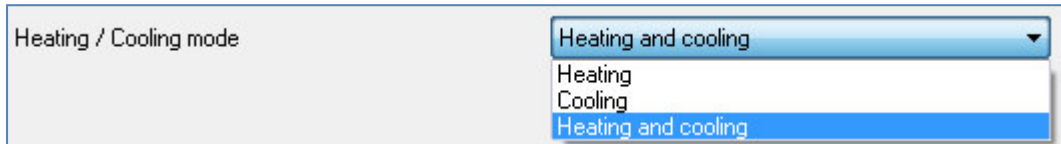

Figure 22: Heating/cooling mode

This switchover causes, that the controlling can be adjusted according to its use. At the heating, only heating control parameters are shown and at the cooling only cooling control parameters. At an combined controlling, both parameters are shown.

Additional a new submenu is shown at the operating mode “integrated controller”. The controller can be parameterized at this submenu.

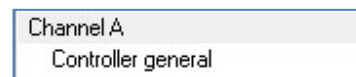

Figure 23: Submenu “integrated controller”

The submenu “controller general” for the heating mode is shown at the following illustration:

Controller general	
	Frost/Comfort/Night/Standby
Basic comfort setpoint (°C)	21,0 °C
Standby reduction (K)	2,0 K
Night reduction (K)	3,0 K
Max setpoint offset (K)	3,0 K
Setpoint value offset over	2Byte-Object
Max setpoint offset valid for	Comfort
Reset setpoint offset after change of mode	No
Send setpoint change	No
Send status on object 50 "Mode selection"	No
Heating system	Warm water heating (4K / 120 min)
Message if value <	8 °C
Message if value >	35 °C

Figure 24: Controller general

The parameterization options for the integrated controller are described at the following sections:

4.5.1 Operating modes

The integrated controller contains of different operating modes, which can be individually adjusted as described below:

Basic comfort setpoint (°C)	21,0 °C
Setpoint heating	
Standby reduction (K)	2,0 K
Night reduction (K)	3,0 K
Setpoint cooling	
Standby increase (K)	3,0 K
Night increase (K)	2,0 K

Figure 25: Operating modes for heating & cooling

The dynamic range of this parameter is shown at the chart:

Sub function	Dynamic range [default value]	comment
Basic comfort setpoint	18,0°C, 18,5°C, 19,0°C, ..., 25°C [21°C]	Adjustment of the basic setpoint; valid for heating and cooling
Setpoint heating		
Standby reduction (K)	0K, 0,5K, 1,0K, ..., 10,0K [2,0K]	Adjustment of the reduction at the heating mode and adjusted standby mode
Night reduction (K)	0K, 0,5K, 1,0K, ..., 10,0K [3,0K]	Adjustment of the reduction at the heating mode and adjusted night mode
Setpoint cooling:		
Standby increase (K)	0K, 0,5K, 1,0K, ..., 10,0K [2,0K]	Adjustment of the increment at the cooling mode and adjusted standby mode
Night increase (K)	0K, 0,5K, 1,0K, ..., 10,0K [3,0K]	Adjustment of the increment at the cooling mode and adjusted night mode

Table 35: Operating modes

If the controller is selected only as heating or as cooling, only settings for the adjusted operating mode are shown.

The operating modes with their differences are described at the following sections.

4.5.1.1 Operating mode Comfort

The operating mode comfort is the reference mode of the controller. The temperature reduction at the operating modes night and standby refer to the setpoint of the comfort mode. When a room is used, the operating mode comfort should be activated. The configured setpoint, the “basic comfort setpoint, is valid for the heating process if the controller was set as heating & cooling (described at 4.5.7 Additional settings at combined heating & cooling mode).

The chart shows the relevant 1-Bit communication object:

Number	Name	Length	Usage
13	Mode comfort	1 Bit	Activation of the operating mode comfort

Table 36: Communication object operating mode comfort

4.5.1.2 Operating mode Night

The operating mode night shall cause a significant decrement of the temperature, for example at night or at the weekend. The reduction can be programmed freely and refers to the basic comfort setpoint. If you have programmed a reduction of 5K and a basic comfort setpoint of 21°C, the setpoint for the night mode will be 16°C.

The chart shows the relevant 1-Bit communication object:

Number	Name	Length	Usage
14	Mode night	1 Bit	Activation of the operating mode night

Table 37: Communication object operating mode night

4.5.1.3 Operating mode Standby

When nobody is in the room, the operating mode standby is used. This operating mode shall cause a low reduction of the temperature. So the room can be heated up fast again.

The value for the reduction can be programmed freely and refers to basic comfort setpoint. If you have adjusted a reduction of 2K and a basic comfort setpoint of 21°C, the setpoint for the operating mode standby will be 19°C.

The standby mode cannot be activated by a certain communication object. It gets activated, when all operating modes are switched off.

4.5.1.4 Operating mode Frost/Heat protection

The operating mode frost protection gets activated, when the controller type was set as heating. The heat protection gets activated, when the controller type was set as cooling. When the controller type is set to heating and cooling, the combined operating mode frost-/ heat protection is activated.

This operating mode causes an automatically switch on of heating or cooling, when a parameterized is exceeded or the temperature falls below a parameterized temperature. At this operating mode, the temperature is set as absolute value. You should activate this function if you are longer absent and the temperature must not fall below a specific value or exceed a specific value.

The chart shows the relevant 1-Bit communication objects:

Number	Name	Length	Usage
15	Mode frost/heat protection	1 Bit	Activation of the operating mode frost/heat protection

Table 38: Communication object operating mode frost/heat protection

4.5.2 Priority of the operating modes

The illustration shows the settings for the priority of the operating modes:

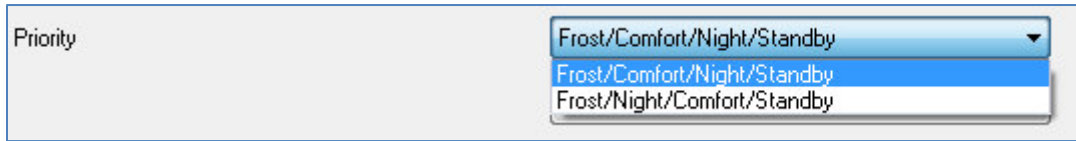

Figure 26: Priority of the operating modes

The chart shows the dynamic range of the priority of the operating modes:

Sub function	Dynamic range [default value]	comment
Priority	<ul style="list-style-type: none"> ▪ Frost/Comfort/Night/Standby ▪ Frost/Night/Comfort/Standby 	Adjustment of the priority of the operating modes

Table 39: Priority of the operating modes

The setting of the priority enables to adjust which operating mode shall be switched primarily when more than one operating mode is switched on. At the priority of Frost/Comfort/Night/Standby, the comfort mode will be switched on even if comfort and night is switched on to the same time. The night mode will only be active, when the comfort mode is switched off. now the controller changes automatically to the night mode.

4.5.3 Operating mode switchover

There are 2 possibilities for the switchover of the operating modes: On the one hand the operating modes can be switched on by their 1 Bit communication object and on the other hand by a 1 Byte object (from Version 1.2).

The selection of the operating modes by their 1 Bit communication object occurs via a direct selection of their individual communication object. With consideration of the adjusted priority, the operating mode, which was selected via the 1 Bit communication object, is switched on or off. When all operating modes are switched off, the controller changes to the standby mode.

Example:

The priority was set as Frost/Comfort/Night/Standby.

Operating mode				adjusted operating mode
Comfort	Night	Frost-/ Heat protection		
1	0	0		Comfort
0	1	0		Night
0	0	1		Frost-/Heat protection
0	0	0		Standby
1	0	1		Frost-/Heat protection
1	1	0		Comfort

Table 40: Example operating mode switchover via 1 Bit

The changeover of the operating modes via 1 Byte occurs by only one object, with the size of 1 Byte, the DPT_HVAC Mode 20.102 of KNX-specification. Additional, there are 2 objects for the visualization available, the 1 Byte object "DPT_HVAC Status" and the 2 Byte object "DPT_RHCC Status". For the changeover of the operating modes, a Hex-value is sent to the object "mode selection". The object evaluates the received value and switches the belonging operating mode on and the active operating mode off. If all operating modes are switched off (Hex-value=0), the operating mode standby will be switched on.

The Hex-values for the operating modes are shown at the chart:

Operating mode (HVAC Mode)	Hex-Value
Comfort	0x01
Standby	0x02
Night	0x03
Frost/Heat protection	0x04

Table 41: Hex-values operating modes

The following example shall clarify how the controller handles received Hex-values and switches operating modes on or off. The chart is to read from the top to the down.

Example:

The priority was set as Frost/Comfort/Night/Standby.

received Hex-value	Handling	adjusted operating mode
0x01	Comfort=1	Comfort
0x03	Comfort=0 Night=1	Night
0x02	Night=0 Standby=1	Standby
0x04	Frost-/Heat protection=1 Standby=0	Frost-/Heat protection

Table 42: Example operating mode switchover via 1 Byte

The object "Mode selection" can also send its current state, by activating the following parameter:

Send status on object 10 "Mode selection"

This setting can be apply only for hardware starting from version 2.2

Figure 27: Send state on "Mode selection"

Thus, the object also sends the status according to Table 41: Hex-values operating modes. The values agree with the KNX standard and can be evaluated, without further processing, for example, from Gira Home server.

The DPT HVAC Status communication, DPT_HVAC Status (without number) of KNX-specification, object sends the hex value for the adjusted operating mode. When more than one testify is valid, the hex values are added and the communication object sends the added value. The hex values can be read from visualization afterwards.

The following chart shows the hex values for the single messages:

Bit	DPT HVAC Status		Hex-Value
0	Comfort	1=Comfort	0x01
1	Standby	1=Standby	0x02
2	Night	1=Night	0x04
3	Frost-/Heat protection	1= Frost-/Heat protection	0x08
4			
5	Heating/Cooling	0=Cooling/1=Heating	0x20
6			
7	Frost alarm	1=Frost alarm	0x80

Table 43: Hex-Values DPT HVAC Status

If you heat at the comfort mode, the communication object will send the value 20 (for heating) +1 (for the comfort mode) =21.

The DPT RHCC Status object is an additional 2 Byte status object with additional status messages. If more than one testify is valid, also here the values will be added in the same way as at the HVAC object.

The following chart shows the hex values for the single messages:

Bit	DPT RHCC Status		Hex-Value
0	Error Sensor	1=Error	0x01
8	Heating/Cooling	0=Cooling/1=Heating	0x100
13	Frost alarm	1=Frost alarm	0x2000
14	Heat alarm	1=Heat alarm	0x4000

Table 44: Hex-Values DPT RHCC Status

The Controller reacts always to the value, which was sent last. If you switched the operating mode last via 1 Bit, the controller will react to the changeover by 1 Bit. If you switched the operating mode last via 1 Byte, the controller will react to the changeover by 1 Byte.

The communication objects for the mode selection are shown at the following chart. The first 3 communication objects are for the 1 Bit changeover, the last 3 objects are for the changeover via 1 Byte:

Number	Name	Length	Usage
11	Mode Comfort	1 Bit	Activation of the mode comfort
12	Mode Night	1 Bit	Activation of the mode night
13	Mode Frost/Heat protection	1 Bit	Activation of the mode Frost/ Heat protection
25	DPT_HVAC Status	1 Byte	Visualization of the chosen operating mode
30	DPT_RHCC Status	2 Byte	Visualization measuring/ status of the controller
31	mode selection	1 Byte	Selection of the operating mode

Table 45: Communication objects for the operating mode changeover

4.5.4 Setpoint offset

The following settings are available at the ETS-Software:

Max setpoint offset	3,0K
Max setpoint offset valid for	Comfort
Reset setpoint offset after change of mode	No
Send setpoint change	Yes

Figure 28: Setpoint offset

The following chart shows the dynamic range for this parameter:

ETS-text	Dynamic range [default value]	comment
Max setpoint offset	0K – 10,0K [3,0K]	indicates the maximal offset
Setpoint value offset over*	<ul style="list-style-type: none"> ▪ 2 Byte ▪ 1 Bit 	Adjustment of the object for the setpoint offset
Max setpoint offset valid for	<ul style="list-style-type: none"> ▪ Comfort ▪ Comfort/Night/Standby 	scope of the setpoint offset
Reset setpoint offset after change of mode	<ul style="list-style-type: none"> ▪ No ▪ Yes 	Adjustment, whether a setpoint offset is still valid after change of operating mode or not
Send setpoint change	<ul style="list-style-type: none"> ▪ No ▪ Yes 	Adjustment, whether a change of mode should be send or not

Table 46: Setpoint offset

* only from Hardware Revision 2.0

The setpoint can be changed manual by the setpoint offset without a new parameterization by the ETS-Software. Therefore, 2 variants are available. On the one hand a new setpoint can be pretended by the communication object "Setpoint comfort". On the other hand the adjusted setpoint can be increased or decreased manual by the communication object "manual setpoint value offset". At the read in of a new absolute comfort setpoint, the controller becomes a new basis comfort setpoint. The new basic comfort setpoint causes also an adaption of the indirect setpoints at the other operating modes. Through this function it is for example possible to read the actual room temperature as new basic comfort setpoint in. The settings "max setpoint offset", "max setpoint offset valid for" and "Reset setpoint offset after change of mode" are not valid at this variant of setpoint offset, because the controller becomes a complete new setpoint. Specifying a new value is possible by calling the object "Setpoint comfort".

The second opportunity of the manual setpoint offset is the movement of the setpoint depending to the adjusted adjusted setpoint. For this variant of setpoint offset, the object “manual setpoint value offset” is used. Sending a positive Kelvin value at this object causes an increment of the current setpoint. Sending a negative Kelvin value at this object causes a decrement of the adjusted setpoint. By sending 0K the setpoint, which is adjusted in the parameters is active again. From Hardware Version 2.0, it can be adjusted if the manual setpoint value offset should be performed by 1 Byte or 1 Bit command.

By activating the Setpoint offset with setwheel at the device-specification with setwheel, the communication object number 7 “manual setpoint offset change” disappears. The manual setpoint offset is performed by the setwheel now (have a look at 4.1.1).

Sending a new setpoint via the object “setpoint comfort” deletes an active setpoint offset.

The setting “max setpoint offset” indicates the maximal possible setpoint movement. If the controller is for example set to a basic comfort setpoint of 3K, the setpoint can only be moved manual in the limits of 18°C and 24°C.

The setting “max setpoint offset valid for” defines the scope of the setpoint offset. You can choose whether the setpoint offset is only valid for the comfort mode or also for the night and standby mode. The operating mode frost/ heat protection is always independent of the setpoint offset.

The setting „Reset setpoint after change of mode” indicates whether a setpoint offset shall be maintained after a change of mode or not. If this parameter is deactivated, the device will switch to the adjusted setpoint for the chosen operating mode after every change of mode.

The communication object “Actual setpoint” is for the query of the current setpoint at the actual adjusted operating mode.

The following chart shows the relevant communication objects:

Number	Name	Length	Usage
7	Setpoint comfort	2 Byte	Parameterization of a new absolute comfort setpoint
8	Manual setpoint value offset	2 Byte	Movement of the setpoint depending to the current adjusted basic comfort setpoint
8	Manual setpoint value offset	1 Bit	Movement of the setpoint depending to the current adjusted basic comfort setpoint 1 = +0,5°C / 0 = -0,5°C
9	Actual setpoint	2 Byte	Readout of the actual adjusted setpoint

Table 47: Communication objects setpoint offset

4.5.5 Message function

The message function can show the increment or decrement of a certain temperature via its communication object:

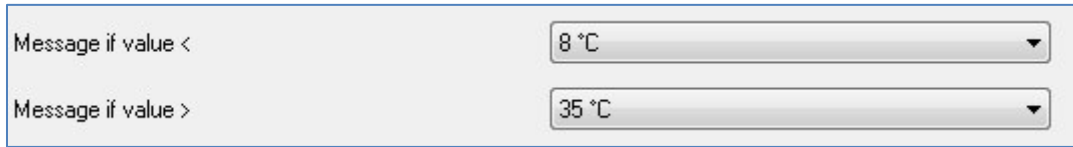

Figure 29: Message function

Die Einstellmöglichkeiten für diesen Parameter sind in der nachfolgenden Tabelle dargestellt:

Sub function	Dynamic range [default value]	comment
Message if value <	inactive, 1°C-25°C [8°C]	Adjustment of the lower report value; Setting available if message function is activated
Message if value >	inactive, 18°C-40°C [35°C]	Adjustment of the upper report value; Setting available if message function is activated

Table 48: Message function

The message function reports a decrement or increment by the belonging object. The increment of the upper value is shown by the heat alarm and the decrement of the lower value is shown by the frost alarm. Both objects have the size of 1 Bit and can be used for visualizations or to introduce counteractions.

The following chart shows the objects:

Number	Name	Length	Usage
16	Frost alarm	1 Bit	reports the decrement of the lower report value
17	Heat alarm	1 Bit	reports the increment of the upper report value

Table 49: Communication objects message function

4.5.6 Heating/Cooling system

The actuator can be adapted to the given heating/cooling system by control parameters. The settings are the same for heating and cooling:

Heating system	Adjustment via control parameter
Proportional range (K)	2 K
Reset time (min)	150 min

Figure 30: Heating/cooling system

The following chart shows the dynamic range for this parameter:

Sub function	Dynamic range [default value]	comment
Heating/Cooling system	<ul style="list-style-type: none"> ▪ Warm water heating (5K/150min) ▪ Underfloor heating (5K/240min) ▪ Split Unit (4K/90min) ▪ Adjustment via control parameter 	Adjustment of the used heating/cooling system. Individual parameterizations available by setting number 4
Proportional range (K)	1K-8K [2K]	If "Adjustment via control parameter" is selected for the heating/cooling system, the proportional range can be chosen freely
Reset time (min)	15min – 210 min [150 min]	If "Adjustment via control parameter" is selected for the heating/cooling system, the reset time can be chosen freely

Table 50: Heating/cooling system

The control parameter, proportional range and reset time, are adjusted by the setting for the heating/cooling system.

It is possible to use predefined values, which fit to certain heating/cooling systems, or to parameterize the proportional range and the reset time individually. The predefined values for the belonging heating or cooling system are based on practical tested values and lead mostly to good control results.

If a free Adjustment is chosen, proportional range and reset time can be chosen freely. This setting needs enough knowledge at the area of control engineering.

4.5.6.1 Proportional range

The proportional range describes the P-amount of the controlling. The P-amount produces a proportional increment to the deviation of the control value.

A small proportional range causes a short recovery time of the deviation. The controller reacts thereby almost immediately and sets the control value already at a small deviation almost to the maximum value (=100%). If the proportional range is chosen too small, the system will swing across. A proportional range of 4K means a control deviation of 4°C causes a control value of 100%. So a control deviation of 1°C will cause a control value of 25%.

The following setting rules can be defined:

- **small proportional range:** swing across possible at change of setpoint; usage at fast systems; small recovery times
- **big proportional range:** almost no danger of swing across; long recovery times, usage at slow systems which need huge amplifications (big heating power etc.)

4.5.6.2 Reset time

The reset time describes the I-amount of the controlling. The I-amount of a controlling causes an integral convergence of the actual value to the setpoint. A short reset time indicates a strong I-amount.

A short reset time causes that the control value approaches fast to the control value, which is set by the proportional range. A big reset time causes a slow approach to this value.

To note is, that a reset time, which is adjusted too small, can cause across swinging. In principle you can say each carrier the system, each bigger the reset time.

The following setting rules can be defined:

- **small reset time:** fast regulating of deviations; usage at fast systems and at places with changing environmental conditions (disturbance variables like draft); danger of swinging across
- **big reset time:** slow regulating of deviations; almost no danger for swinging across; usage at slow systems as underfloor heating

4.5.7 Additional settings at combined heating & cooling mode

If the integrated controller is adjusted with heating and cooling mode, it must be adjusted whether a combined circuit or a divided circuit is given:

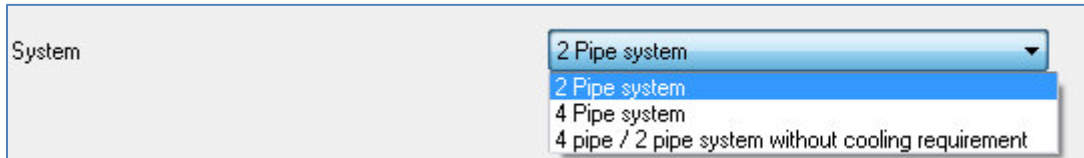

Figure 31: Combined systems

The following chart shows the dynamic range of this parameter:

Sub function	Dynamic range [default value]	comment
System	<ul style="list-style-type: none"> ▪ 2 Pipe system ▪ 4 Pipe system ▪ 4 Pipe system without cooling requirement 	Adjustment whether combined or divided systems are given

Table 51: Combined systems

At the setting “2 Pipe system“, a combined heating and cooling system is given. So one channel controls one and the same valve for heating and cooling.

If the setting “4 Pipe system“ is selected, a divided system is given with an own cooling circuit and an own heating circuit. Because two valves are given, the valves must be controlled from different channels. So an extra communication object, called “PWM cooling for 4 pipe system“, is shown. This object can be processed arbitrarily, e.g. from another channel, selected as continuous.

Additional there is a setting, called “4 Pipe system without cooling requirement“. This setting effects that no heating/cooling requirement is sent, when the cooling is activated.

The communication object for a 4 pipe system is shown at the chart:

Number	Name	Length	Usage
6	PWM cooling for 4 pipe system	1 Byte	Control value for the cooling mode

Table 52: Communication object for 4 pipe system

5 Index

5.1 Register of Illustrations

Figure 1: Exemplary circuit diagram heating actuator 4-fold 230V	5
Figure 2: Exemplary circuit diagram heating actuator 4-fold 230V	5
Figure 3: Overview hardware module.....	6
Figure 4: global Communication objects (AKH-0800.01)	10
Figure 5: Communication objects „switching (1Bit)“	11
Figure 6: Communication objects „continuous (1Byte) “	11
Figure 7: Communication objects „integrated controller“	12
Figure 8: Setup general.....	16
Figure 9: Device configuration	16
Figure 10: Summer/Winter mode	17
Figure 11: Heating/Cooling switchover	18
Figure 12: Protection of force fit	19
Figure 13: max. Control value	20
Figure 14: Behavior after bus power reset.....	21
Figure 15: Mode selection	22
Figure 16: Channel configuration – “switching“	23
Figure 17: Emergency mode.....	25
Figure 18: Forced position/Dew point alarm	26
Figure 19: Channel configuration – “continuous”	28
Figure 20: Limitation of the control value.....	32
Figure 21: Flow temperature limit	33
Figure 22: Heating/cooling mode.....	34
Figure 23: Submenu “integrated controller”	34
Figure 24: Controller general	35
Figure 25: Operating modes for heating & cooling	36
Figure 26: Priority of the operating modes	38
Figure 27: Send state on "Mode selection"	39
Figure 28: Setpoint offset	41
Figure 29: Message function	43
Figure 30: Heating/cooling system.....	44
Figure 31: Combined systems	46

5.2 List of tables

Table 1: Overview functions.....	8
Table 2: global Communication objects	10
Table 3: Communication objects „switching(1Bit)“	11
Table 4: Communication objects „continuous(1Byte)“	12
Table 5: Communication objects integrated controller	13
Table 6: Default-settings of the communication objects	14
Table 7: Device configuration.....	16
Table 8: Communication object fault	17
Table 9: Summer/Winter mode	17
Table 10: Communication object Summer/Winter mode.....	17
Table 11: Heating/Cooling switchover	18
Table 12: Communication object Summer/Winter mode.....	19
Table 13: Protection of forse fit	19
Table 14: max. Control value.....	20
Table 15: Communication objects max. Control value	20
Table 16: Behavior after bus power reset.....	21
Table 17: Mode selection	22
Table 18: Communication object Control value 1Bit	23
Table 19: Valve type	23
Table 20: Heating/cooling requirement.....	24
Table 21: Send state control value	24
Table 22: Communication object state control value	24
Table 23: Blocking function	25
Table 24: Communication object blocking function.....	25
Table 25: Emergency mode	25
Table 26: Forced position/Dew point alarm.....	26
Table 27: Communication object dew point alarm.....	26
Table 28: Forced position	27
Table 29: Communication object forced position	27
Table 30: Communication objects control value – 1 Byte.....	28
Table 31: PWM cycletime.....	29
Table 32: Limitation of the control value	32
Table 33: Flow temperature limit.....	33
Table 34: Communication object flow temperature.....	33
Table 35: Operating modes	36
Table 36: Communication object operating mode comfort.....	37
Table 37: Communication object operating mode night	37
Table 38: Communication object operating mode frost/heat protection	37
Table 39: Priority of the operating modes	38
Table 40: Example operating mode switchover via 1 Bit	38
Table 41: Hex-values operating modes	39
Table 42: Example operating mode switchover via 1 Byte	39
Table 43: Hex-Values DPT HVAC Status.....	40
Table 44: Hex-Values DPT RHCC Status.....	40
Table 45: Communication objects for the operating mode changeover	40
Table 46: Setpoint offset	41
Table 47: Communication objects setpoint offset	42
Table 48: Message function	43

Table 49: Communication objects message function	43
Table 50: Heating/cooling system	44
Table 51: Combined systems.....	46
Table 52: Communication object for 4 pipe system	46

6 Attachment

6.1 Statutory requirements

The above-described devices must not be used with devices, which serve directly or indirectly the purpose of human, health- or lifesaving. Further the devices must not be used if their usage can occur danger for humans, animals or material assets.

Do not let the packaging lying around careless, plastic foil/ -bags etc. can be a dangerous toy for kids.

6.2 Routine disposal

Do not throw the waste equipment in the household rubbish. The device contains electrical devices, which must be disposed as electronic scrap. The casing contains of recyclable synthetic material.

6.3 Assemblage



Risk for life of electrical power!

All activities on the device should only be done by an electrical specialist. The county specific regulations and the applicable EIB-directives have to be observed.

6.4 Controller

Three different controller types can be chosen for the control value. These controller types are described for the heating process by the following illustrations.

6.4.1 2-Step control

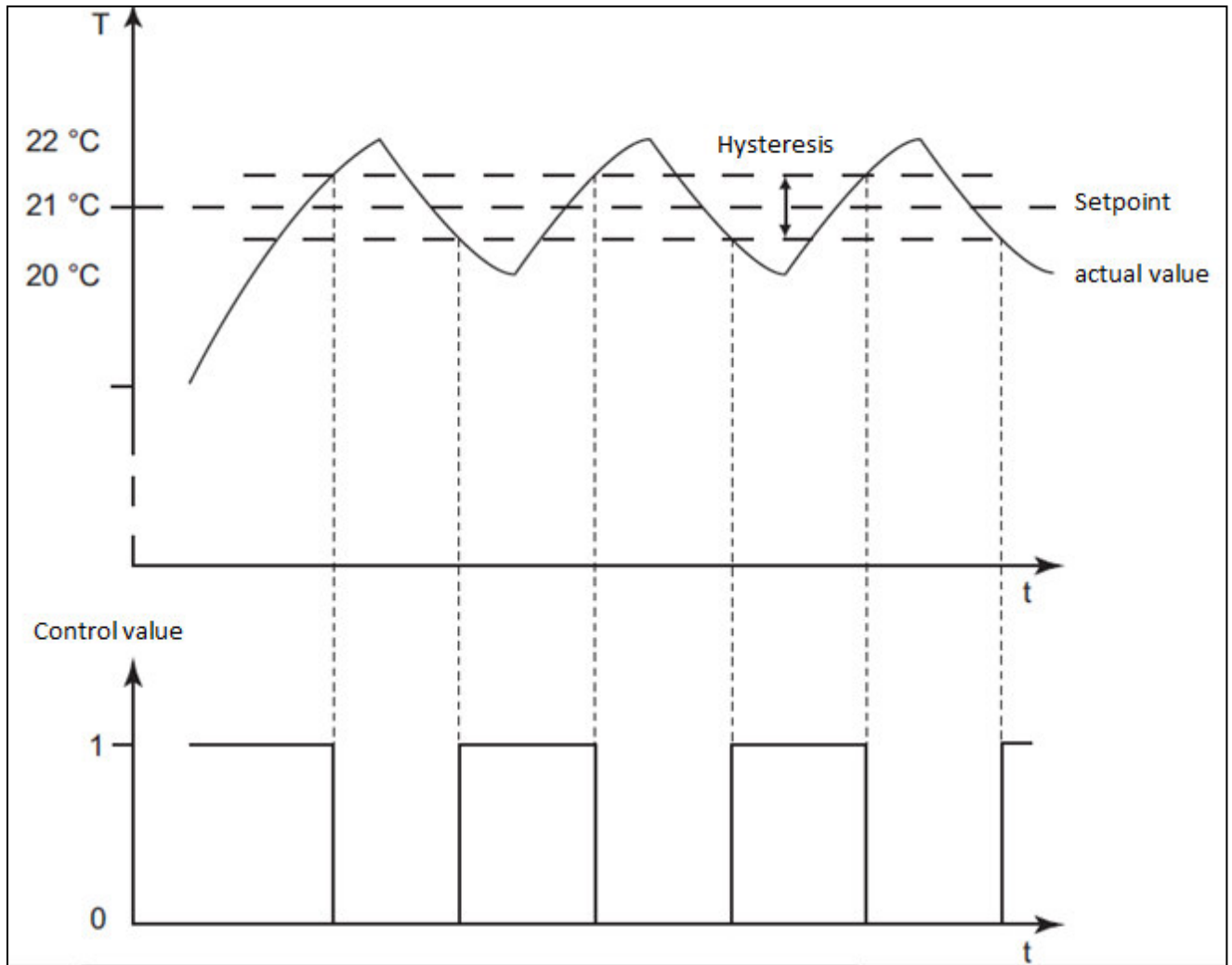

6.4.2 PI-control continuous

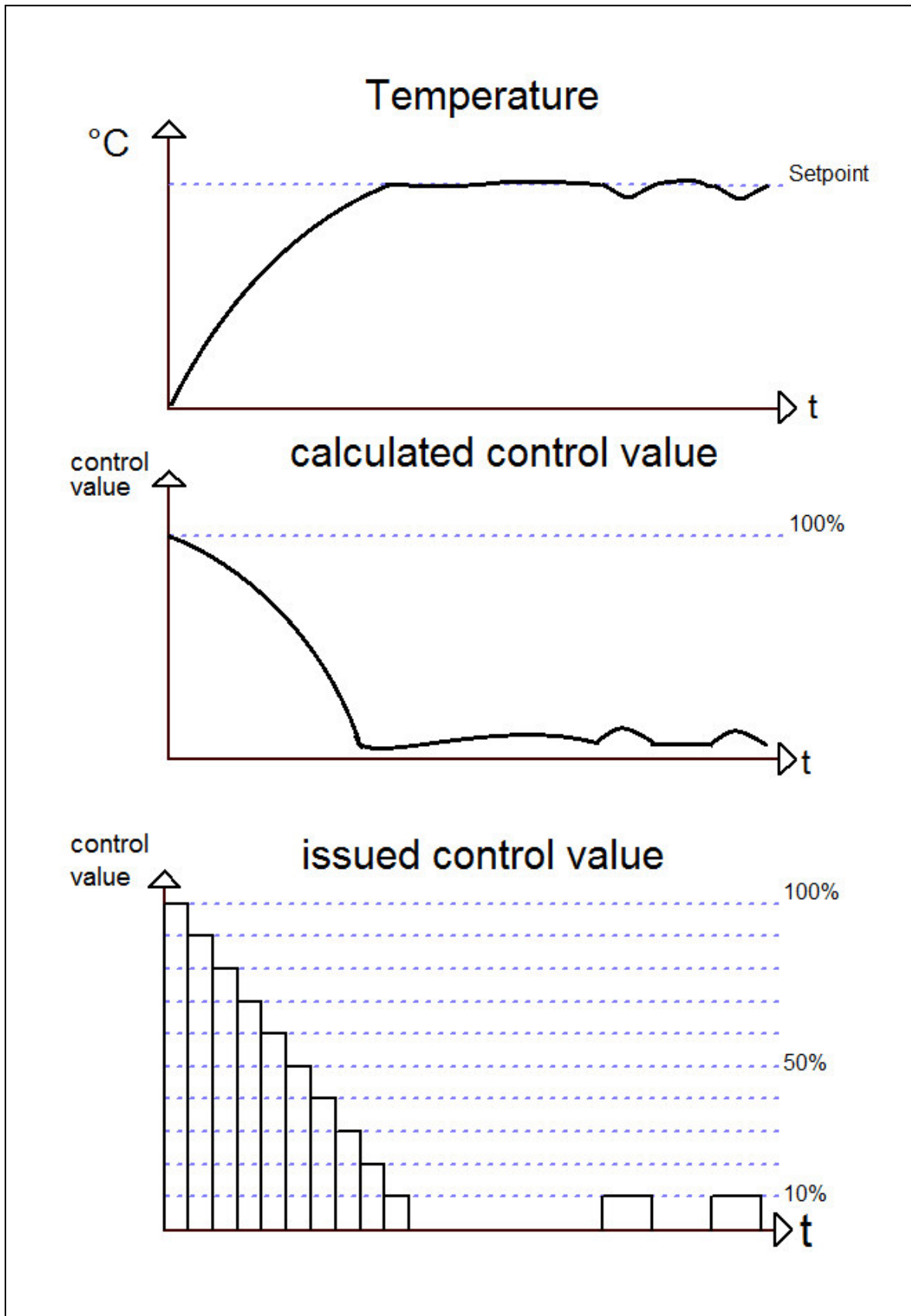

6.4.3 PI-control switching (PWM)

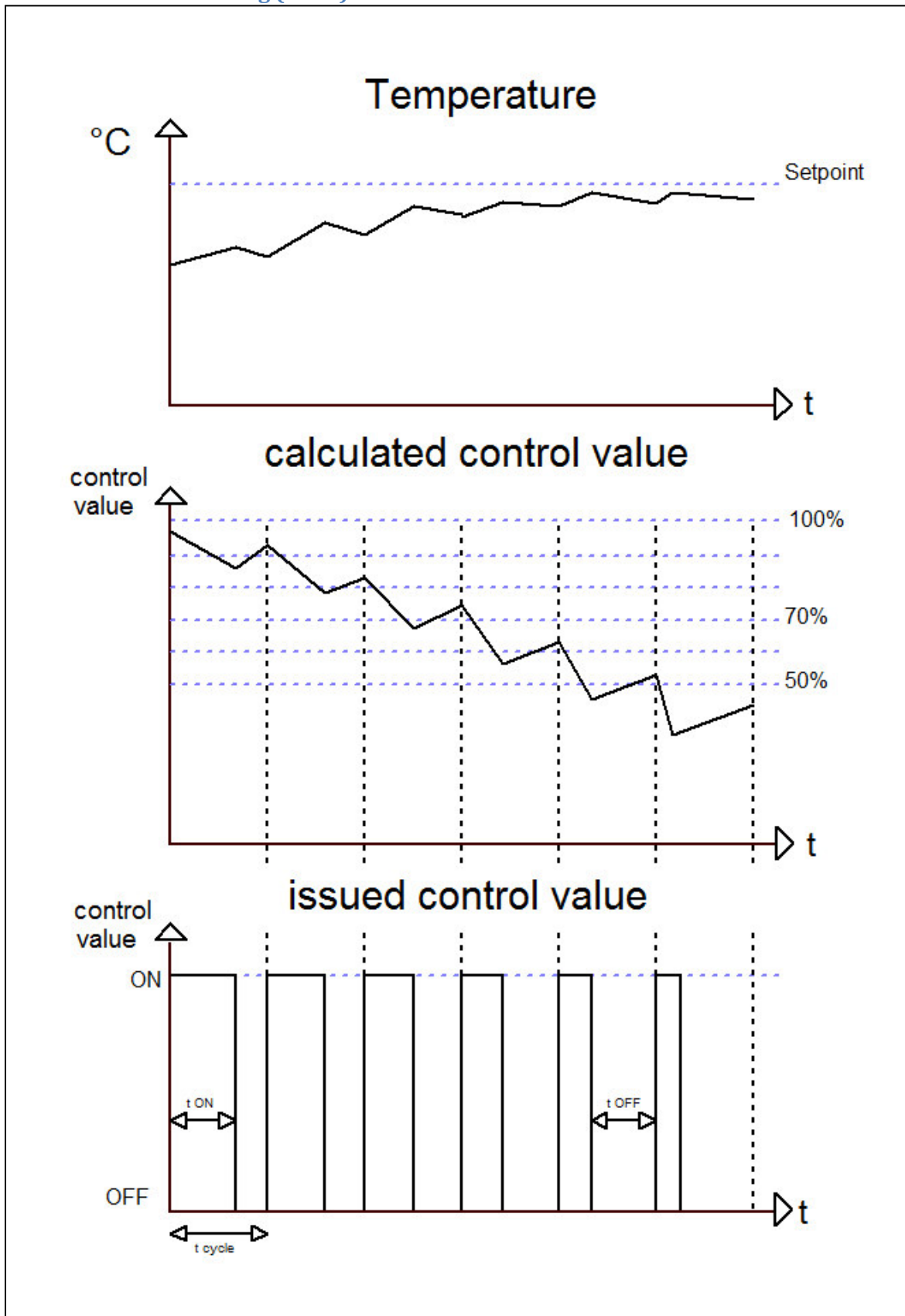

6.5 Direction of controller

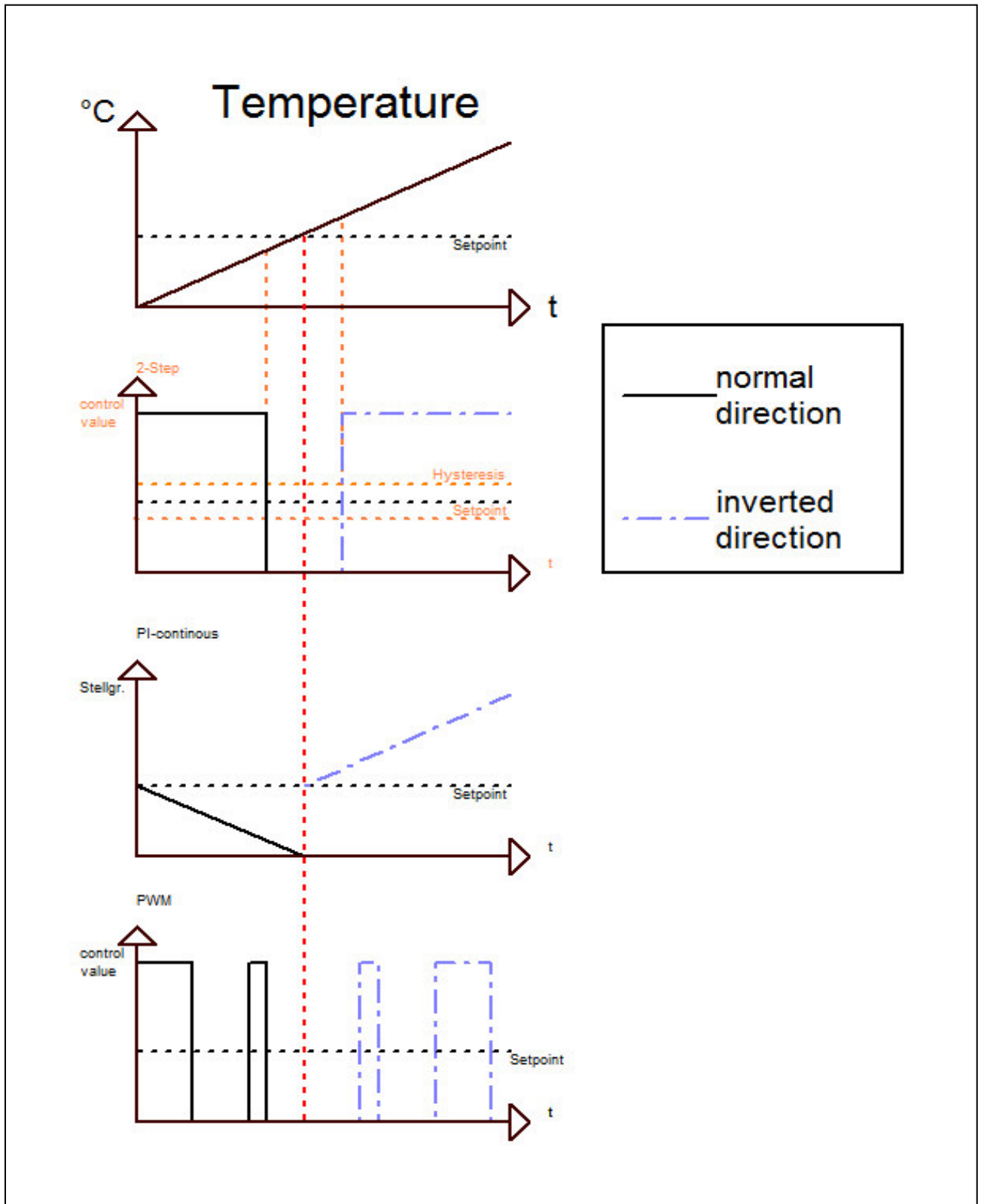

6.5 Datasheet

MDT Heating Actuator 4/8-fold, MDRC

Version		
AKH-0400.01	Heating Actuator 4-fold	2SU MDRC, to control electrothermic valve drives 24-230VAC
AKH-0800.01	Heating Actuator 8-fold	4SU MDRC, to control electrothermic valve drives 24-230VAC

The MDT Heating Actuator receives KNX/EIB telegrams and controls up to independent electrical outputs . Each channel has its own LED indicator.

Each channel supplies up to 4 electrothermic valve drives and can be parameterized individually via ETS3/4. The channels are controllable with PWM (1-bit) or 1-byte telegrams. The integrated temperature controller manages the actuating value given by external KNX temperature sensors. The temperature controller offers comfort-, night-, frost protection- and summer- /winter- operation.

The MDT Heating Actuator detects mains voltage failure and has emergency operation if the cyclic telegram is missing. Additionally they provide objects for heating request and cyclic movement of the valves.

The MDT Heating Actuator is a modular installation device for fixed installation in dry rooms. It fits on DIN 35mm rails in power distribution boards or closed compact boxes.

For project design and commissioning of the MDT Heating Actuator it is recommended to use the ETS3f/ETS4 or later. Please download the application software at www.mdt.de/Downloads.html

AKH-0400.01



AKH-0800.01

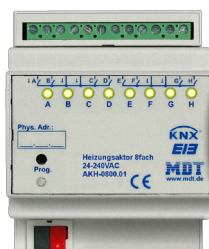

- Production in Germany, certified according to ISO 9001
- Each channel controls up to 4 electrothermic valve drives
- Controllable with 1-bit (Switching/PWM) or 1-byte telegram
- Direct controllable with temperature value via KNX bus
- **Integrated PI temperature controller (Heating and Cooling)**
- Given value is stored at voltage failure
- Bit object +/- to set the given value
- Comfort-, night- and frost protection. Summer-/winter operation
- Emergency operation if cyclic telegram is missing
- Short-circuit detection of connected load
- Detection of 230VAC mains voltage failure
- Objects for heating request and cyclic movement of the valves
- Modular installation device for DIN 35mm rails
- Integrated bus coupling unit
- 3 years warranty

Technical Data	AKH-0400.01 AKH-0800.01
Number of outputs	4/8
Output switching current	
24VAC and ohmic load	500mA
230VAC and ohmic load	500mA
max. inrush current**	5A
External switching voltage	24-230VAC
Maximum load	
Number of electrothermic valves*	230VAC: 4 each channel 24VAC: 3 each channel
Output life expectancy	Triac output, wearless
Permitted wire gauge	
Screw terminal	0,5 - 4,0mm ² solid core 0,5 - 2,5mm ² finely stranded
KNX busconnection terminal	0,8mm Ø, solid core
Power supply	KNX bus
Power consumption KNX bus typ.	< 0,3W
Operation temperature range	0 to + 45°C
Enclosure	IP 20

* depends on manufacturer. Inrush current for 4 electrothermic valves has to be < 1A each electrothermic valve ** every group of four outputs

